

SAMSUNG

USER MANUAL

SM-T390
SM-T395

English (EU). 06/2019. Rev.1.0

www.samsung.com

Table of Contents

Basics

- 4 Read me first
- 7 Device overheating situations and solutions
- 11 Device layout and functions
- 18 Battery
- 23 SIM or USIM card (nano-SIM card) (SM-T395)
- 24 Memory card (microSD card)
- 26 Protective case
- 27 Turning the device on and off
- 28 Initial setup
- 29 Samsung account
- 31 Transferring data from your previous device (Smart Switch)
- 33 Understanding the screen
- 44 Notification panel
- 46 Entering text

Apps and features

- 49 Installing or uninstalling apps
- 51 S Pen features
- 63 Phone (SM-T395)
- 68 Contacts
- 73 Messages (SM-T395)
- 76 Internet
- 78 Email
- 79 Camera
- 89 Gallery
- 95 Multi window
- 98 Samsung Members
- 98 Samsung Notes
- 104 PENUP
- 110 Calendar
- 112 Samsung Flow
- 114 My Files
- 114 Clock
- 116 Calculator
- 117 Bixby Home
- 119 Reminder
- 123 SmartThings
- 127 Sharing content
- 128 Google apps

Settings

- 130 Introduction
- 130 Connections
 - 132 Wi-Fi
 - 134 Bluetooth
 - 136 NFC and payment
 - 138 Data saver (SM-T395)
 - 139 Mobile Hotspot and Tethering (SM-T395)
 - 140 More connection settings
- 142 Sounds and vibration
 - 143 Separate app sound
- 143 Notifications
 - 144 App icon badges
- 144 Display
 - 145 Blue light filter
 - 146 Screensaver
- 146 Wallpaper
- 147 Lock screen
 - 148 Smart Lock
- 149 Biometrics and security
 - 150 Face recognition
 - 153 Fingerprint recognition
 - 157 Samsung Pass
 - 162 Secure Folder
- 167 Accounts and backup
 - 168 Users
 - 170 Samsung Cloud
- 171 Google
- 172 Advanced features
- 173 Device care
- 175 Apps

- 176 General management
- 177 Accessibility
- 177 Software update
- 178 User manual
- 178 About tablet

Appendix

- 179 Troubleshooting

Basics

Read me first

Please read this manual before using the device to ensure safe and proper use.

- Descriptions are based on the device's default settings.
- Some content may differ from your device depending on the region, service provider, model specifications, or device's software.
- Content (high quality content) that requires high CPU and RAM usage will affect the overall performance of the device. Apps related to the content may not work properly depending on the device's specifications and the environment that it is used in.
- Samsung is not liable for performance issues caused by apps supplied by providers other than Samsung.
- Samsung is not liable for performance issues or incompatibilities caused by edited registry settings or modified operating system software. Attempting to customise the operating system may cause the device or apps to work improperly.
- Software, sound sources, wallpapers, images, and other media provided with this device are licensed for limited use. Extracting and using these materials for commercial or other purposes is an infringement of copyright laws. Users are entirely responsible for illegal use of media.
- You may incur additional charges for data services, such as messaging, uploading and downloading, auto-syncing, or using location services depending on your data plan. For large data transfers, it is recommended to use the Wi-Fi feature. (SM-T395)
- Default apps that come with the device are subject to updates and may no longer be supported without prior notice. If you have questions about an app provided with the device, contact a Samsung Service Centre. For user-installed apps, contact service providers.

- Modifying the device's operating system or installing softwares from unofficial sources may result in device malfunctions and data corruption or loss. These actions are violations of your Samsung licence agreement and will void your warranty.
- Depending on the region or service provider, a screen protector is attached for protection during production and distribution. Damage to the attached screen protector is not covered by the warranty.
- You can see the touchscreen clearly even in strong outdoor sunlight by automatically adjusting the contrast range based on the surrounding environment. Due to the nature of the product, displaying fixed graphics for extended periods may result in afterimages (screen burn-in) or ghosting.
 - It is recommended not to use fixed graphics on part or all of the touchscreen for extended periods and turn off the touchscreen when not using the device.
 - You can set the touchscreen to turn off automatically when you are not using it. Launch the **Settings** app, tap **Display** → **Screen timeout**, and then select the length of time you want the device to wait before turning off the touchscreen.
 - To set the touchscreen to automatically adjust its brightness based on the surrounding environment, launch the **Settings** app, tap **Display**, and then tap the **Adaptive brightness** switch to activate it.
- Depending on the region or model, some devices are required to receive approval from the Federal Communications Commission (FCC). If your device is approved by the FCC, you can view the FCC ID of the device. To view the FCC ID, launch the **Settings** app and tap **About tablet** → **Status**.
- Depending on the region, you can view the regulatory information on the device. To view the information, launch the **Settings** app and tap **About tablet** → **Regulatory information**.

Maintaining water and dust resistance

Your device supports water- and dust-resistance. Follow these tips carefully to maintain the water- and dust-resistance of your device. Failure to do so may result in damage to your device.

- Do not immerse the device in fresh water deeper than 1.5 m or keep it submerged for more than 30 minutes. If you immerse the device in any liquid other than fresh water, such as salt water, ionised water, or alcoholic beverage, liquid will enter the device faster.
- Do not expose the device to **water moving with force**.
- If the device is exposed to fresh water, dry it thoroughly with a clean, soft cloth. If the device is exposed to other liquids, such as salt water, ionised water, or alcoholic beverage, rinse it with fresh water and dry it thoroughly with a clean, soft cloth. If you do not follow these instructions, the device's performance and appearance may be affected.
- **If the device has been immersed in water or the microphone or speaker is wet**, sound may not be heard clearly during a call. After wiping the device with a dry cloth, dry it thoroughly before using it.
- The touchscreen and other features may not work properly **if the device is used in water**.
- **If the device is dropped or receives an impact**, the water- and dust-resistant features of the device may be damaged.
- **Your device has been tested in a controlled environment and certified to be water- and dust-resistant in specific situations (meets requirements of classification IP68 as described by the international standard IEC 60529-Degrees of Protection provided by Enclosures [IP Code]; test conditions: 15-35 °C, 86-106 kPa, fresh water, 1.5 metre, 30 minutes). Despite this classification, it is still possible for your device to be damaged in certain situations.**

Instructional icons



Warning: situations that could cause injury to yourself or others



Caution: situations that could cause damage to your device or other equipment



Notice: notes, usage tips, or additional information

Device overheating situations and solutions

When the device heats up while charging the battery

While charging, the device and the charger may become hot. During wireless charging or fast charging, the device may feel hotter to the touch. This does not affect the device's lifespan or performance and is in the device's normal range of operation. If the battery becomes too hot, the charger may stop charging.

Do the following when the device heats up:

- Disconnect the charger from the device and close any running apps. Wait for the device to cool down and then begin charging the device again.
- If the lower part of the device overheats, it could be because the connected USB cable is damaged. Replace the damaged USB cable with a new Samsung-approved one.
- When using a wireless charger, do not place foreign materials, such as metal objects, magnets, and magnetic stripe cards, between the device and the wireless charger.



The wireless charging or fast charging feature is only available on supported models.

When the device heats up during use

When you use features or apps that require more power or use them for extended periods, your device may temporarily heat up due to increased battery consumption. Close any running apps and do not use the device for a while.

The following are examples of situations in which the device may overheat. Depending on the functions and apps you use, these examples may not apply to your model.

- During the initial setup after purchase or when restoring data
- When downloading large files
- When using apps that require more power or using apps for extended periods
 - When playing high-quality games for extended periods
 - When recording videos for extended periods
 - When streaming videos while using the maximum brightness setting
 - When connecting to a TV
- While multitasking (or, when running many apps in the background)
 - When using Multi window
 - When updating or installing apps while recording videos
 - When downloading large files during a video call
 - When recording videos while using a navigation app
- When using large amount of data for syncing with the cloud, email, or other accounts
- When using a navigation app in a car while the device is placed in direct sunlight
- When using the mobile hotspot and tethering feature
- When using the device in areas with weak signals or no reception
- When charging the battery with a damaged USB cable
- When the device's multipurpose jack is damaged or exposed to foreign materials, such as liquid, dust, metal powder, and pencil lead
- When you are roaming

Do the following when the device heats up:

- Keep the device updated with the latest software.
- Conflicts between running apps may cause the device to heat up. Restart the device.
- Deactivate the Wi-Fi, GPS, and Bluetooth features when not using them.
- Close apps that increase battery consumption or that run in the background when not in use.
- Delete unnecessary files or unused apps.
- Decrease the screen brightness.
- If the device overheats or feels hot for a prolonged period, do not use it for a while. If the device continues to overheat, contact a Samsung Service Centre.

Device limitations when the device overheats

When the device heats up, the features and performance may be limited or the device may turn off to cool down. The feature is only available on supported models.

- If the device becomes hotter than usual, a device overheating message will appear. To lower the device's temperature, the screen brightness and the performance speed will be limited and battery charging will stop. Running apps will be closed and you will only be able to make emergency calls until the device cools down.
- If the device overheats or feels hot for a prolonged period, a power off message will appear. Turn off the device, and wait until it cools down.

Precautions for operating environment

Your device may heat up due to the environment in the following conditions. Use caution to avoid shortening the battery's lifespan, damaging the device, or causing a fire.

- Do not store your device in very cold or very hot temperatures.
- Do not expose your device to direct sunlight for extended periods.
- Do not use or store your device for extended periods in very hot areas, such as inside a car in the summertime.
- Do not place the device in any areas that may overheat, such as on an electric heating mat.
- Do not store your device near or in heaters, microwaves, hot cooking equipment, or high pressure containers.
- Never use a damaged charger or battery.

Device layout and functions

Package contents

Refer to the quick start guide for package contents.



- The items supplied with the device and any available accessories may vary depending on the region or service provider.
- The supplied items are designed only for this device and may not be compatible with other devices.
- Appearances and specifications are subject to change without prior notice.
- You can purchase additional accessories from your local Samsung retailer. Make sure they are compatible with the device before purchase.
- Use only Samsung-approved accessories. Using unapproved accessories may cause the performance problems and malfunctions that are not covered by the warranty.
- Availability of all accessories is subject to change depending entirely on manufacturing companies. For more information about available accessories, refer to the Samsung website.

Device layout

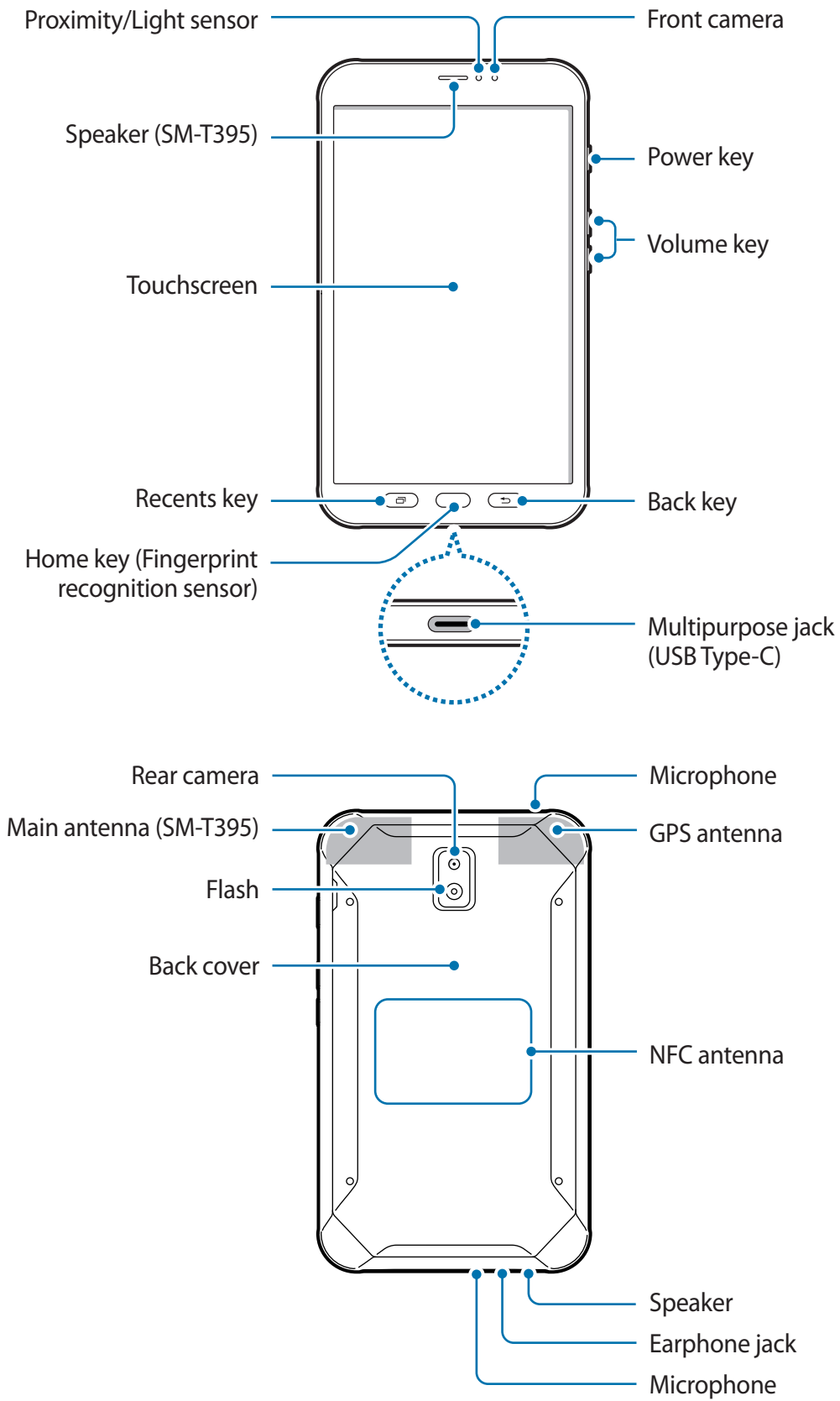









- When using the speakers, such as when playing media files or using speakerphone, do not place the device close to your ears.
- Be careful not to expose the camera lens to a strong light source, such as direct sunlight. If the camera lens is exposed to a strong light source, such as direct sunlight, the camera image sensor may be damaged. A damaged image sensor is irreparable and will cause dots or spots in pictures.
- If you use the device with its glass or acrylic body broken, there may be a risk of injury. Use the device only after it has been repaired at a Samsung Service Centre.



- Connectivity problems and battery drain may occur in the following situations:
 - If you attach metallic stickers on the antenna area of the device
 - If you attach a device cover made with metallic material to the device
 - If you cover the device's antenna area with your hands or other objects while using certain features, such as calls or the mobile data connection (SM-T395)
- Using a Samsung-approved screen protector is recommended. Unapproved screen protectors may cause the sensors to malfunction.
- Do not cover the proximity/light sensor area with screen accessories, such as a screen protector or stickers. Doing so may cause the sensor to malfunction.

Keys

Key	Function
 Power	<ul style="list-style-type: none">• Press and hold to turn the device on or off.• Press to turn on or lock the screen.
 Recents	<ul style="list-style-type: none">• Press to open the list of recent apps.
 Home	<ul style="list-style-type: none">• Press to turn on the screen while the screen is locked.• Press to return to the Home screen.• Press and hold to launch Google Assistant.
 Back	<ul style="list-style-type: none">• Press to return to the previous screen.• Press and hold to access additional options for the current screen.
  Volume	<ul style="list-style-type: none">• Press to adjust the device volume.

S Pen

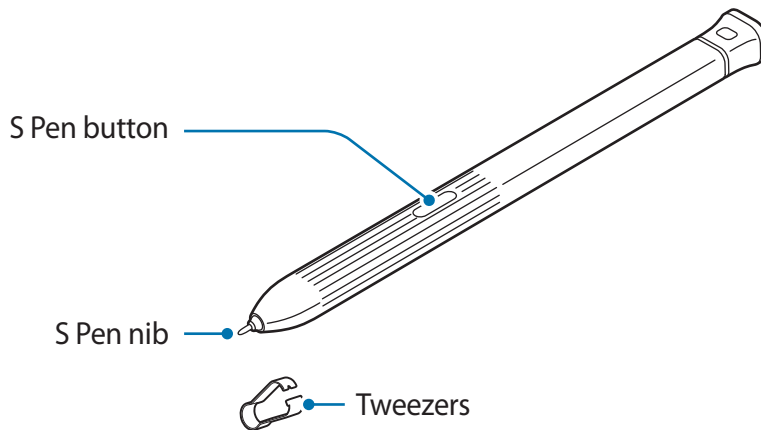

Name	Functions
S Pen nib	<ul style="list-style-type: none"> • Use the S Pen to write, draw, or perform touch actions on the screen. The Recents key and the Back key can be used with the S Pen. • Hover the S Pen over items on the screen to access additional S Pen features, such as the Air view feature.
S Pen button	<ul style="list-style-type: none"> • Hover the S Pen over the screen and press the S Pen button to display the Air command features. • While pressing and holding the S Pen button, drag the S Pen over items to select them.
Tweezers	<ul style="list-style-type: none"> • Remove the S Pen nib with the tweezers when replacing the nib.

Replacing the S Pen nib

If the nib is dull, replace it with a new one.

- 1 Firmly hold the nib with the tweezers and remove it.

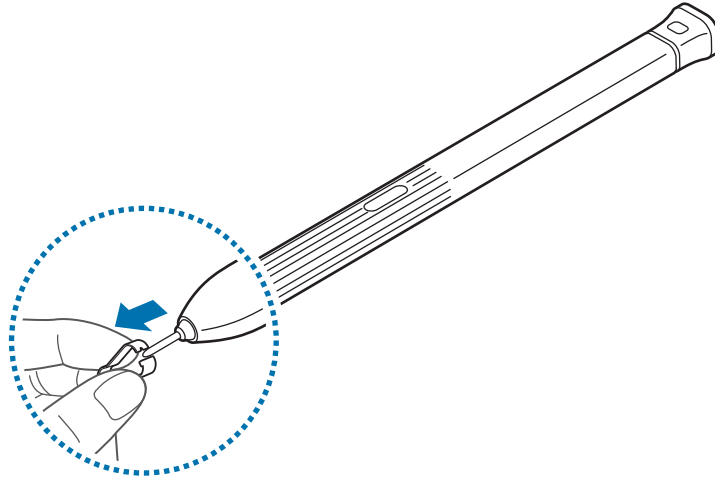

- 2 Insert a new nib into the S Pen.

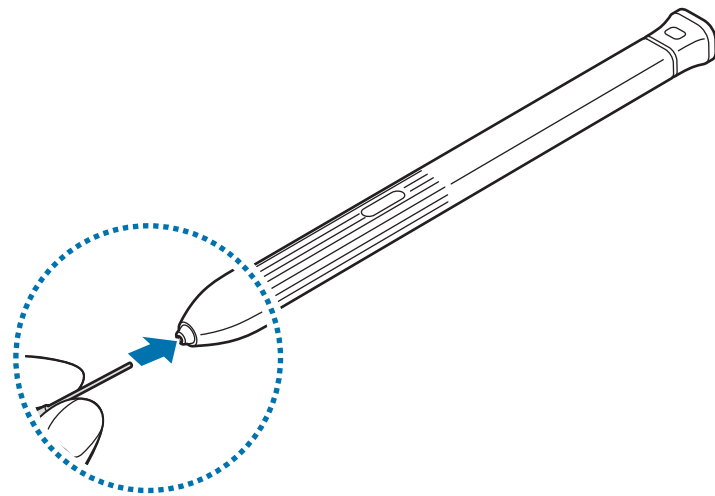



Be careful not to pinch your fingers with the tweezers.



- Do not reuse old nibs. Doing so may cause the S Pen to malfunction.
- Do not press the nib excessively when inserting the nib into the S Pen.
- Do not insert the round end of the nib into the S Pen. Doing so may cause damage to the S Pen or your device.
- Do not bend or apply excessive pressure with the S Pen while using it. The S Pen may be damaged or the nib may be deformed.
- Do not hard press on the screen with the S Pen. The pen nib may be deformed.



- If you use the S Pen at sharp angles on the screen, the device may not recognise the S Pen actions.
- The Recents key and the Back key can be used with the S Pen.
- For more information about the S Pen, visit the Samsung website.
- If the S Pen is not working properly, take it to a Samsung Service Centre.
- You can insert the S Pen into the top of the protective case. Refer to [Installing the S Pen](#) for more information.

Battery

Installing the battery

1 Remove the back cover.

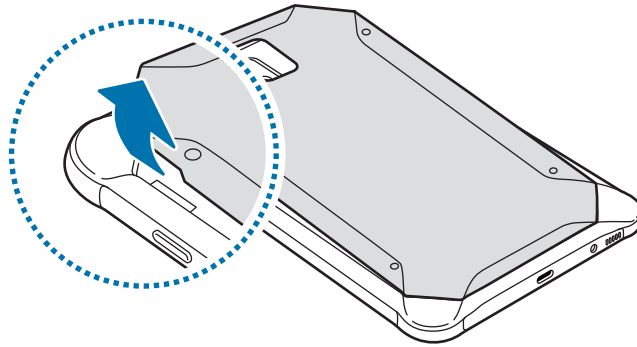

Be careful not to damage your fingernails when you remove the back cover.



Do not bend or twist the back cover excessively. Doing so may damage the cover.

2 Insert the battery with the battery's gold-coloured contacts properly aligned with the device's contacts.

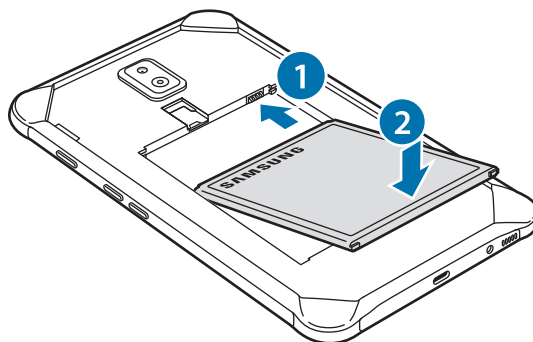

3 Replace the back cover.

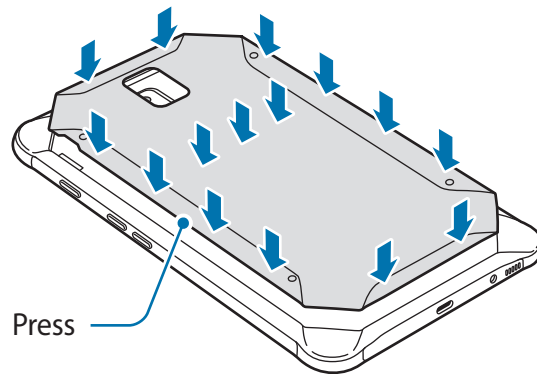

Ensure that the back cover is closed tightly to prevent water and dust from entering the device. Open or loose back cover may allow water and dust to enter the device and cause damage.



Use only Samsung-approved back covers and accessories with the device.

Removing the battery

1 Remove the back cover.

2 Pull out the battery.

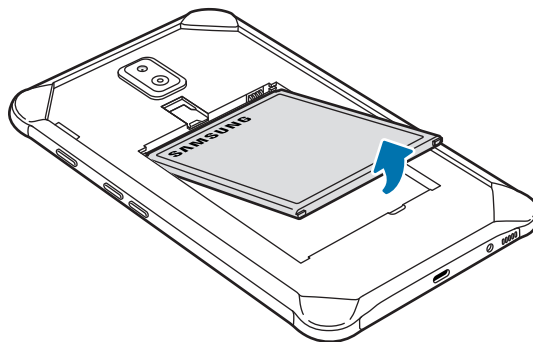

Charging the battery

Charge the battery before using it for the first time or when it has been unused for extended periods.



Use only Samsung-approved chargers, batteries, and cables. Unapproved chargers or cables can cause the battery to explode or damage the device.



- Connecting the charger improperly may cause serious damage to the device. Any damage caused by misuse is not covered by the warranty.
- Use only USB Type-C cable supplied with the device. The device may be damaged if you use Micro USB cable.



To save energy, unplug the charger when not in use. The charger does not have a power switch, so you must unplug the charger from the electric socket when not in use to avoid wasting power. The charger should remain close to the electric socket and easily accessible while charging.

- 1 Connect the USB cable to the USB power adaptor.
- 2 Plug the USB cable into the device's multipurpose jack.

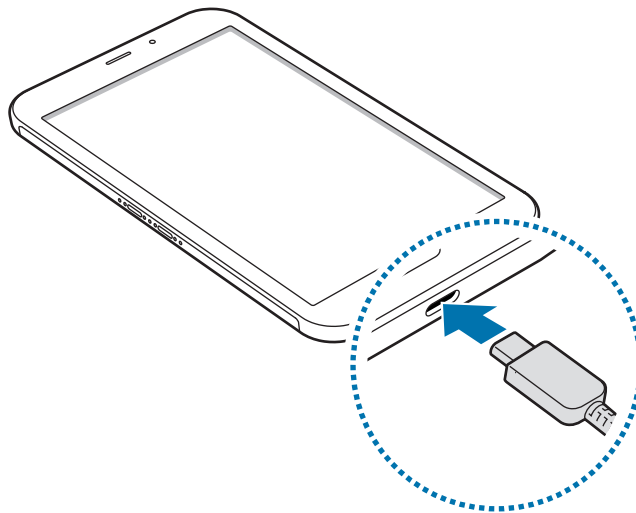

3 Plug the USB power adaptor into an electric socket.

4 After fully charging, disconnect the charger from the device. Then, unplug the charger from the electric socket.



Do not remove the battery before removing the charger. This may damage the device.

Reducing the battery consumption

Your device provides various options that help you conserve battery power.

- Optimise the device using the device care feature.
- When you are not using the device, turn off the screen by pressing the Power key.
- Activate power saving mode.
- Close unnecessary apps.
- Deactivate the Bluetooth feature when not in use.
- Deactivate auto-syncing of apps that need to be synced.
- Decrease the backlight time.
- Decrease the screen brightness.

Battery charging tips and precautions

- When the battery power is low, the battery icon appears empty.
- If the battery is completely discharged, the device cannot be turned on immediately when the charger is connected. Allow a depleted battery to charge for a few minutes before turning on the device.
- If you use multiple apps at once, network apps, or apps that need a connection to another device, the battery will drain quickly. To avoid losing power during a data transfer, always use these apps after fully charging the battery.
- Using a power source other than the charger, such as a computer, may result in a slower charging speed due to a lower electric current.
- The device can be used while it is charging, but it may take longer to fully charge the battery.
- If the device receives an unstable power supply while charging, the touchscreen may not function. If this happens, unplug the charger from the device.
- While charging, the device and the charger may heat up. This is normal and should not affect the device's lifespan or performance. If the battery gets hotter than usual, the charger may stop charging.
- If you charge the device while the multipurpose jack is wet, the device may be damaged. Thoroughly dry the multipurpose jack before charging the device.
- If the device is not charging properly, take the device and the charger to a Samsung Service Centre.

SIM or USIM card (nano-SIM card) (SM-T395)

Installing the SIM or USIM card

Insert the SIM or USIM card provided by the mobile telephone service provider.



- Use only a nano-SIM card.
- Use caution not to lose or let others use the SIM or USIM card. Samsung is not responsible for any damages or inconveniences caused by lost or stolen cards.



Some LTE services may not be available depending on the service provider. For more information about service availability, contact your service provider.

- 1 Remove the back cover and battery.
- 2 Insert the SIM or USIM card with the gold-coloured contacts facing downwards.

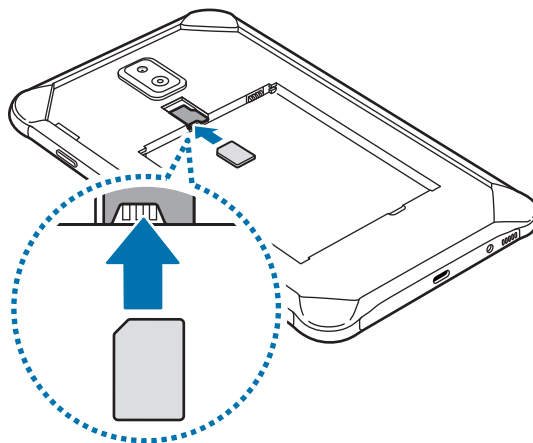

- 3 Replace the battery and back cover.

Removing the SIM or USIM card

- 1 Remove the back cover and battery.
- 2 Pull out the SIM or USIM card.

Memory card (microSD card)

Installing a memory card

Your device's memory card capacity may vary from other models and some memory cards may not be compatible with your device depending on the memory card manufacturer and type. To view your device's maximum memory card capacity, refer to the Samsung website.



- Some memory cards may not be fully compatible with the device. Using an incompatible card may damage the device or the memory card, or corrupt the data stored in it.
- Use caution to insert the memory card right-side up.



- The device supports the FAT and the exFAT file systems for memory cards. When inserting a card formatted in a different file system, the device will ask to reformat the card or will not recognise the card. To use the memory card, you must format it. If your device cannot format or recognise the memory card, contact the memory card manufacturer or a Samsung Service Centre.
- Frequent writing and erasing of data shortens the lifespan of memory cards.
- When inserting a memory card into the device, the memory card's file directory appears in the **My Files** → **SD card** folder.

- 1 Remove the back cover and battery.
- 2 Insert a memory card with the gold-coloured contacts facing downwards.

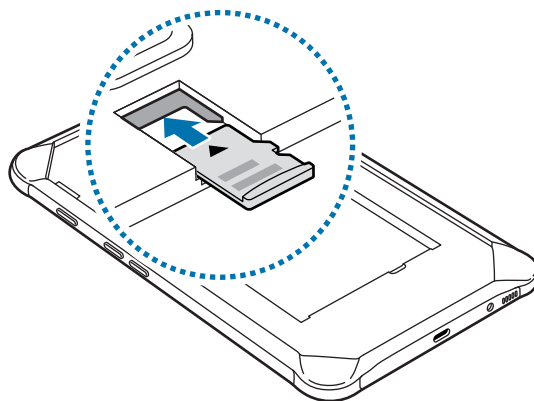

- 3 Replace the battery and back cover.

Removing the memory card

Before removing the memory card, first unmount it for safe removal.

Launch the **Settings** app and tap **Device care** → **Storage** →  → **Storage settings** → **SD card** → **Unmount**.

- 1 Remove the back cover and battery.
- 2 Pull out the memory card.
- 3 Replace the battery and back cover.



Do not remove external storage, such as a memory card or USB storage, while the device is transferring or accessing information, or right after transferring data. Doing so can cause data to be corrupted or lost or cause damage to the external storage or device. Samsung is not responsible for losses, including loss of data, resulting from the misuse of external storage devices.

Formatting the memory card

A memory card formatted on a computer may not be compatible with the device. Format the memory card on the device.

Launch the **Settings** app and tap **Device care** → **Storage** →  → **Storage settings** → **SD card** → **Format**.



Before formatting the memory card, remember to make backup copies of all important data stored in the memory card. The manufacturer's warranty does not cover loss of data resulting from user actions.

Protective case

Installing the protective case

Insert the top of the device into the case, and then press the other side of the case firmly to install it.

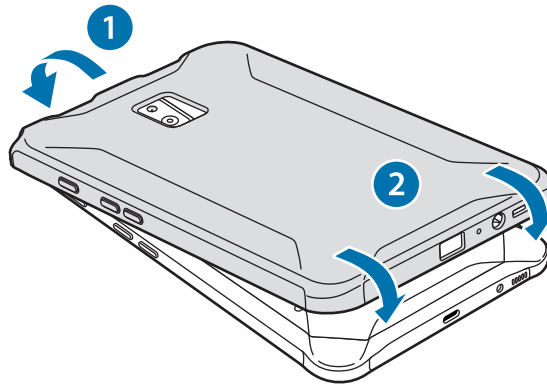

Removing the protective case

Twist the top edge of the case until the device protrudes from it, and then remove the device from the case.

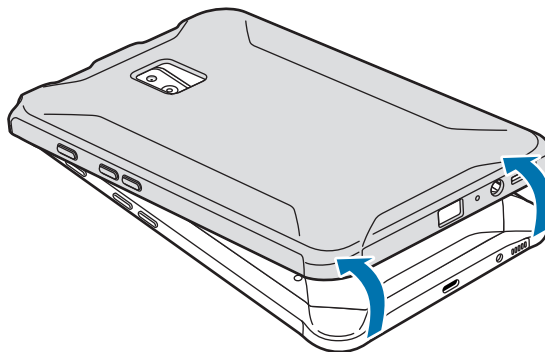

Installing the S Pen

Insert the S Pen into the top of the protective case.

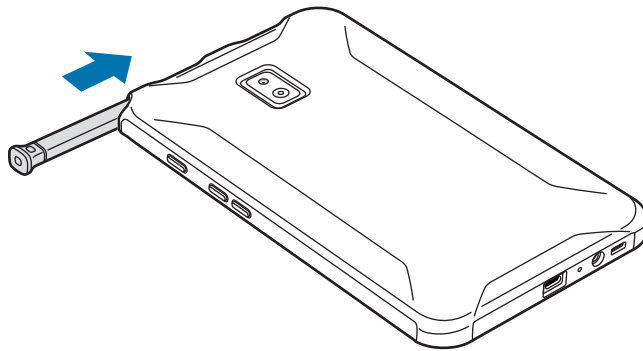

Do not insert the S Pen backwards into the protective case.

Turning the device on and off

Press and hold the Power key for a few seconds to turn on the device.

When you turn on your device for the first time or after performing a data reset, follow the on-screen instructions to set up your device.

To turn off the device, press and hold the Power key, and then tap **Power off**.



- If your device is frozen and unresponsive, press and hold the Power key and the Volume Down key simultaneously for more than 7 seconds to restart it.
- Follow all posted warnings and directions from authorised personnel in areas where the use of wireless devices is restricted, such as aeroplanes and hospitals.

Initial setup

When you turn on your device for the first time or after performing a data reset, follow the on-screen instructions to set up your device.

 The initial setup procedures may vary depending on the device's software and your region.

- 1 Turn on the device.
- 2 Select your preferred device language and select .

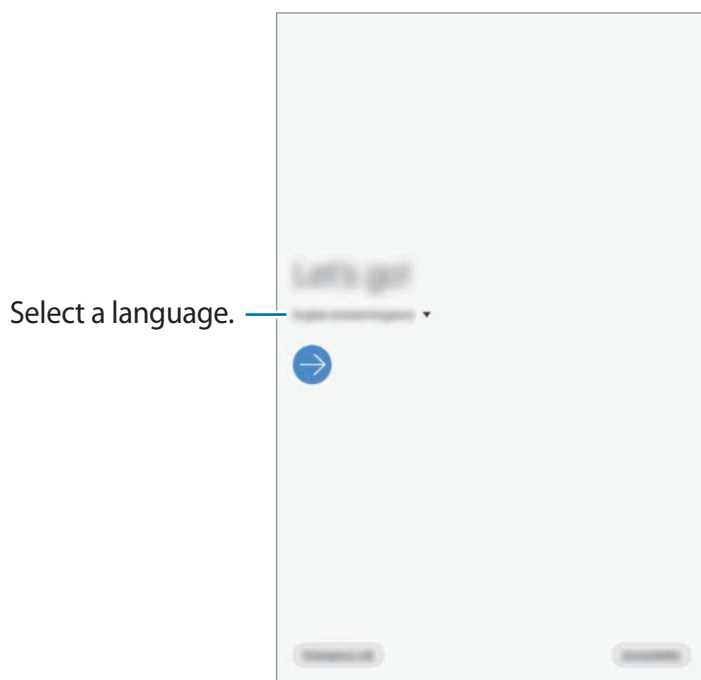

- 3 Read and agree to the terms and conditions and tap **Next**.
- 4 Get your content from a previous device.
- 5 Select a Wi-Fi network and connect to it.

 If you do not connect to a Wi-Fi network, you may not be able to set up some device features during the initial setup.

- 6 Follow the on-screen instructions to proceed the initial setup.
- 7 Set a screen lock method to protect your device. You can protect your personal information by preventing others from accessing your device. To set the screen lock method later, tap **Not now**.
- 8 If the recommended apps screen appears, select apps you want and download them.
- 9 Sign in to your Samsung account. You can enjoy Samsung services and keep your data up to date and secure across all of your devices. Refer to [Samsung account](#) for more information.
- 10 Tap **Finish** to complete the initial setup.
The Home screen will appear.

Samsung account

Introduction

Your Samsung account is an integrated account service that allows you to use a variety of Samsung services provided by mobile devices, TVs, and the Samsung website. Once your Samsung account has been registered, you can keep your data up to date and secure across your Samsung devices with Samsung Cloud, track and control your lost or stolen device, see tips and tricks from Samsung Members, and more.

Create your Samsung account with your email address.

To check the list of services that can be used with your Samsung account, visit account.samsung.com. For more information on Samsung accounts, launch the **Settings** app and tap **Accounts and backup** → **Accounts** → **Samsung account** →  → **Help**.

Registering your Samsung account

Registering a new Samsung account

If you do not have a Samsung account, you should create one.

1 Launch the **Settings** app and tap **Accounts and backup** → **Accounts** → **Add account** → **Samsung account**.

Alternatively, launch the **Settings** app and tap .

2 Tap **Create account**.

3 Follow the on-screen instructions to complete creating your account.

Registering an existing Samsung account

If you already have a Samsung account, register it to the device.

1 Launch the **Settings** app and tap **Accounts and backup** → **Accounts** → **Add account** → **Samsung account**.

Alternatively, launch the **Settings** app and tap .

2 Enter your Samsung account ID and password and tap **Sign in**.

If you forget your account information, tap **Find ID** or **Reset password**. You can find your account information when you enter the required information.

3 Read and agree to the terms and conditions and tap **Next** to finish registering your Samsung account.

Removing your Samsung account

When you remove your registered Samsung account from the device, your data, such as contacts or events, will also be removed.

- 1 Launch the **Settings** app and tap **Accounts and backup** → **Accounts**.
- 2 Tap **Samsung account** →  → **Remove account**.
- 3 Tap **Remove**, enter your Samsung account password, and then tap **OK**.

Transferring data from your previous device (Smart Switch)

Connect with your previous device via Smart Switch to transfer data.

Launch the **Settings** app and tap **Accounts and backup** → **Smart Switch**.



- This feature may not be supported on some devices or computers.
- Limitations apply. Visit www.samsung.com/smartswitch for details. Samsung takes copyright seriously. Only transfer content that you own or have the right to transfer.

Transferring data wirelessly via Wi-Fi Direct

Transfer data from your previous device to your device wirelessly via Wi-Fi Direct.

- 1 On the previous device, launch Smart Switch.
If you do not have the app, download it from **Galaxy Store** or **Play Store**.
- 2 On your device, launch the **Settings** app and tap **Accounts and backup** → **Smart Switch**.
- 3 Place the devices near each other.

- 4 On the previous device, tap **Send data** → **Wireless**.
- 5 On the previous device, select an item to transfer and tap **Send**.
- 6 On your device, tap **Receive**.
- 7 Follow the on-screen instructions to transfer data from your previous device.

Transferring data using external storage

Transfer data using external storage, such as a microSD card.

- 1 Transfer data from your previous device to external storage.
- 2 Insert or connect the external storage device to your device.
- 3 On your device, launch the **Settings** app and tap **Accounts and backup** → **Smart Switch** →  → **Restore**.
- 4 Follow the on-screen instructions to transfer data from external storage.

Understanding the screen

Controlling the touchscreen



- Do not allow the touchscreen to come into contact with other electrical devices. Electrostatic discharges can cause the touchscreen to malfunction.
- To avoid damaging the touchscreen, do not tap it with anything sharp or apply excessive pressure to it with your fingertips.
- It is recommended not to use fixed graphics on part or all of the touchscreen for extended periods. Doing so may result in afterimages (screen burn-in) or ghosting.



- The device may not recognise touch inputs close to the edges of the screen, which are outside of the touch input area.
- It is recommended to use fingers or the S Pen when you use the touchscreen.

Tapping

Tap the screen.

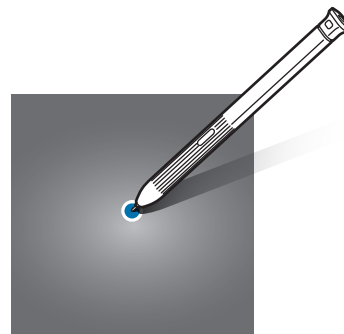
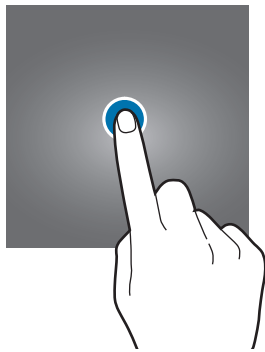

Tapping and holding

Tap and hold the screen for approximately 2 seconds.

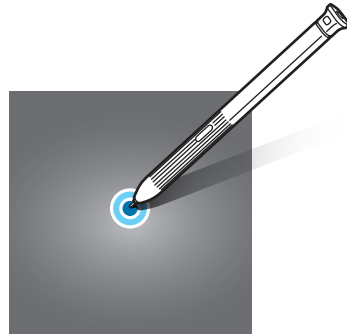
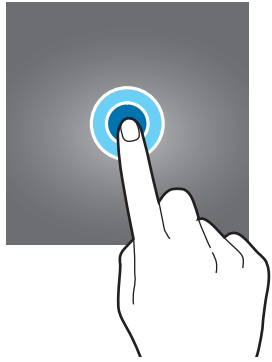

Dragging

Tap and hold an item and drag it to the target position.

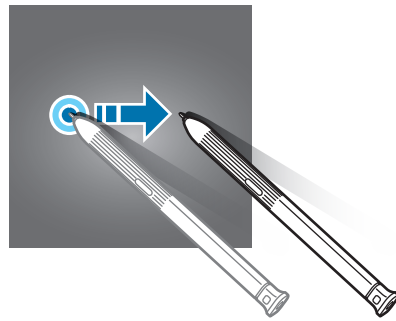
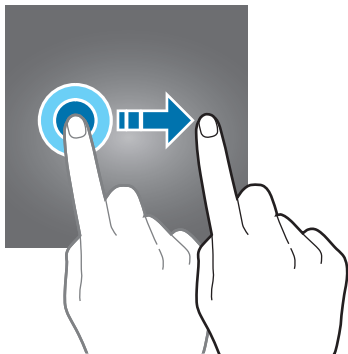

Double-tapping

Double-tap the screen.

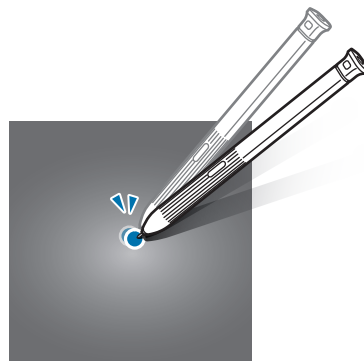
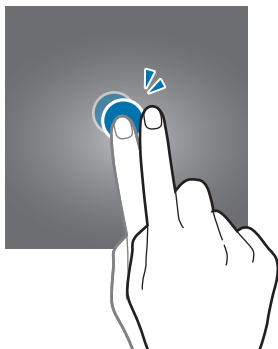

Swiping

Swipe upwards, downwards, to the left, or to the right.

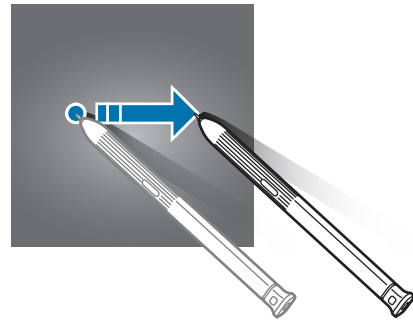
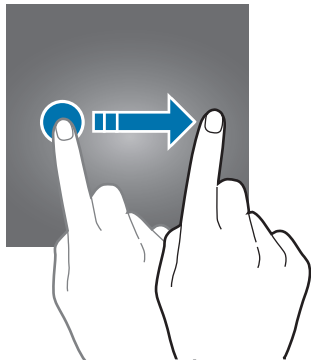

Spreading and pinching

Spread two fingers apart or pinch on the screen.

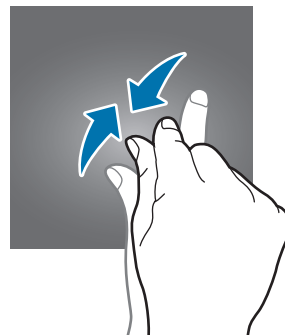
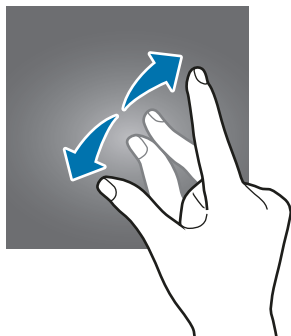

Home screen and Apps screen

The Home screen is the starting point for accessing all of the device's features. It displays widgets, shortcuts to apps, and more.

The Apps screen displays icons for all apps, including newly installed apps.



The screen may appear differently depending on the region or service provider.

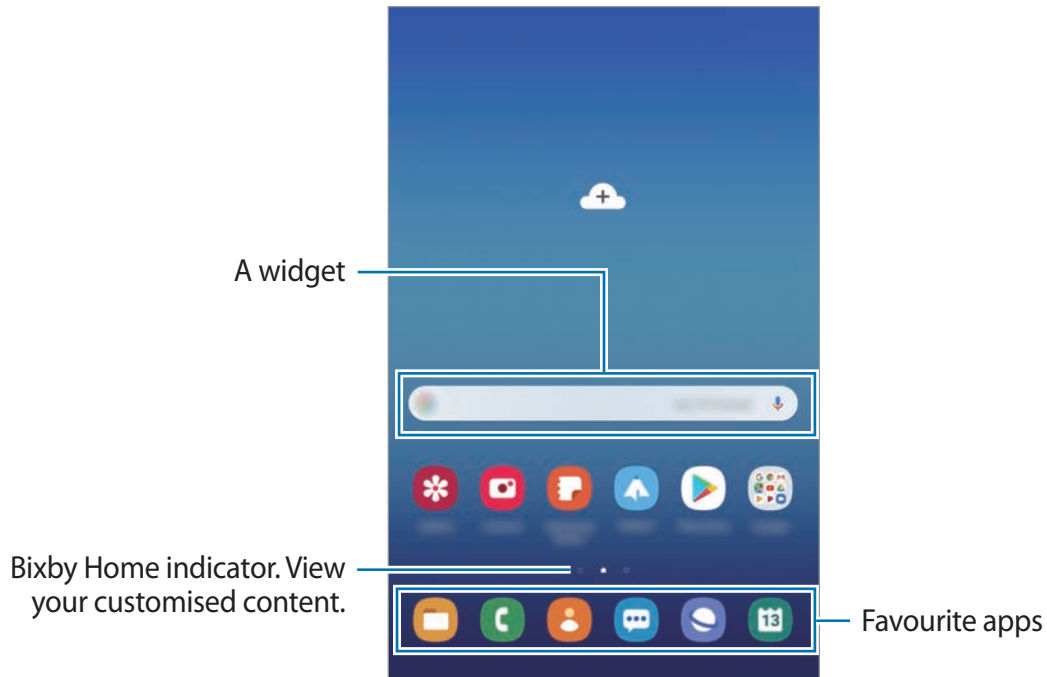

Switching between Home and Apps screens

On the Home screen, swipe upwards or downwards to open the Apps screen.

To return to the Home screen, swipe upwards or downwards on the Apps screen.

Alternatively, press the Home key or the Back key.

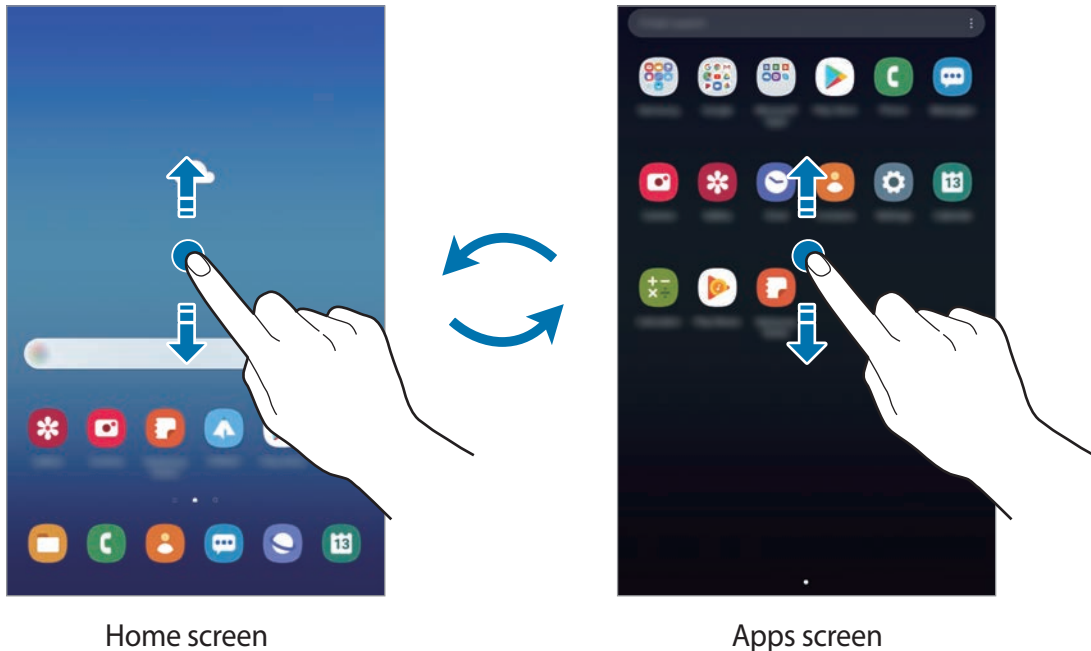

If you add the Apps button on the Home screen, you can open the Apps screen by tapping the button. On the Home screen, tap and hold an empty area, tap **Home screen settings**, and then tap the **Apps button** switch to activate it. The Apps button will be added at the bottom of the Home screen.



Moving items

Tap and hold an item, and then drag it to a new location. To move the item to another panel, drag it to the side of the screen.

To add a shortcut to an app on the Home screen, tap and hold an item on the Apps screen, and then tap **Add to Home**. A shortcut to the app will be added on the Home screen.

You can also move frequently used apps to the shortcuts area at the bottom of the Home screen.

Creating folders

Create folders and gather similar apps to quickly access and launch apps.

On the Home screen or the Apps screen, tap and hold an app, and then drag it over another app.

A new folder containing the selected apps will be created. Tap **Enter folder name** and enter a folder name.

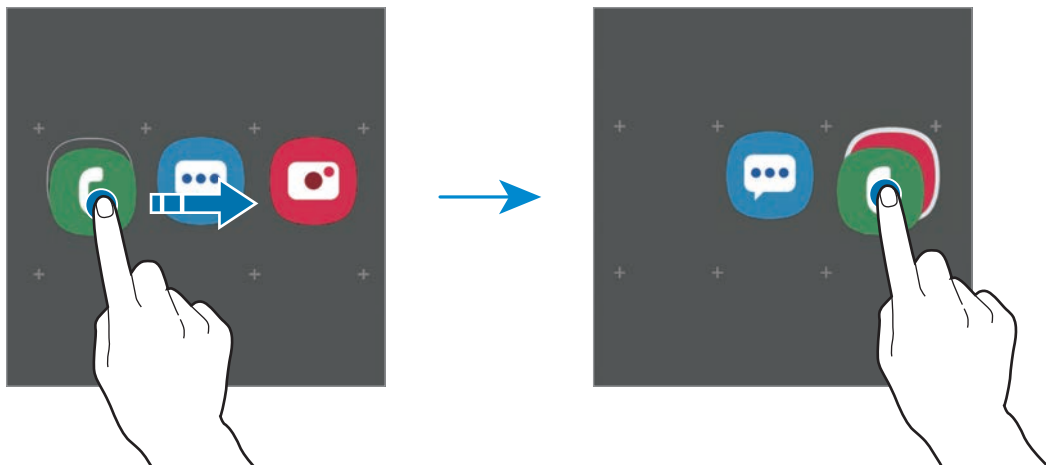

- **Adding more apps**

Tap **Add apps** on the folder. Tick the apps to add and tap **Add**. You can also add an app by dragging it to the folder.

- **Moving apps from a folder**

Tap and hold an app to drag it to a new location.

- **Deleting a folder**

Tap and hold a folder, and then tap **Delete folder**. Only the folder will be deleted. The folder's apps will be relocated to the Apps screen.

Editing the Home screen

On the Home screen, tap and hold an empty area, or pinch your fingers together to access the editing options. You can set the wallpaper, add widgets, and more. You can also add, delete, or rearrange Home screen panels.

- Adding panels: Swipe to the left, and then tap ⊕.
- Moving panels: Tap and hold a panel preview, and then drag it to a new location.
- Deleting panels: Tap 🗑 on the panel.

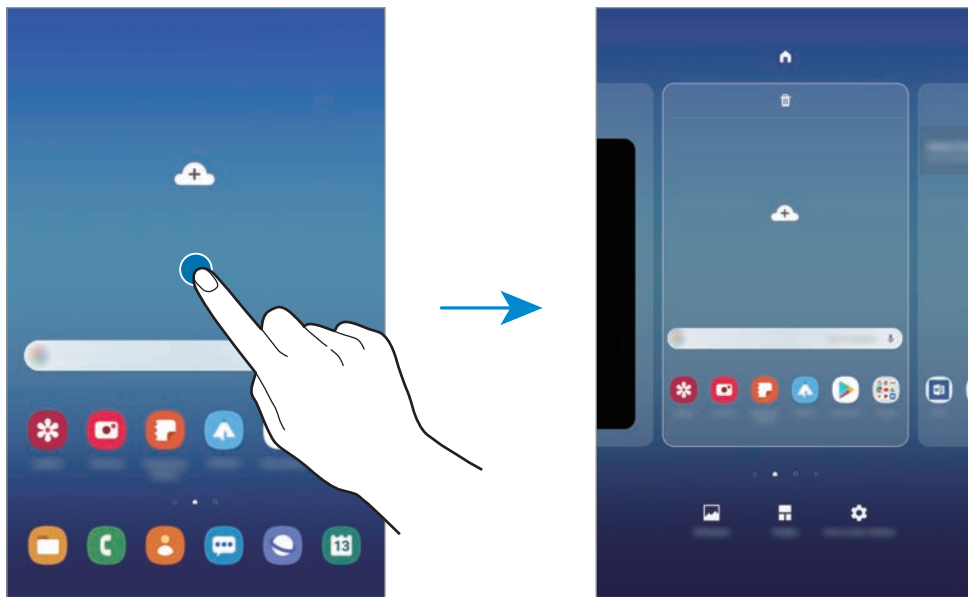

- **Wallpapers:** Change the wallpaper settings for the Home screen and the locked screen.
- **Widgets:** Widgets are small apps that launch specific app functions to provide information and convenient access on your Home screen. Tap and hold a widget, and then drag it to the Home screen. The widget will be added on the Home screen.
- **Home screen settings:** Change the Home screen settings.

Displaying all apps on the Home screen

Without using a separate Apps screen, you can set the device to display all apps on the Home screen. On the Home screen, tap and hold an empty area, and then tap **Home screen settings** → **Home screen layout** → **Home screen only** → **Apply**.

You can now access all your apps by swiping to the left on the Home screen.





Indicator icons

Indicator icons appear on the status bar at the top of the screen. The icons listed in the table below are most common.



- The status bar may not appear at the top of the screen in some apps. To display the status bar, drag down from the top of the screen.
- Some indicator icons appear only when you open the notification panel.
- Call-related features are not supported on some models.

Icon	Meaning
	No signal
	Signal strength
	Roaming (outside of normal service area)
	GPRS network connected
	EDGE network connected
	UMTS network connected
	HSDPA network connected
	HSPA+ network connected
	LTE network connected
	Wi-Fi connected
	Bluetooth feature activated
	Location services being used
	Call in progress
	Missed call
	New text or multimedia message
	Alarm activated
	Mute mode activated

Icon	Meaning
	Vibration mode activated
	Flight mode activated
	Error occurred or caution required
	Battery charging
	Battery power level

Lock screen

Pressing the Power key turns off the screen and locks it. Also, the screen turns off and automatically locks if the device is not used for a specified period.

To unlock the screen, swipe in any direction when the screen turns on.

If the screen is off, press the Power key or the Home key to turn on the screen.



Locked screen

Changing the screen lock method

To change the screen lock method, launch the **Settings** app, tap **Lock screen** → **Screen lock type**, and then select a method.

When you set a pattern, PIN, password, or your biometric data for the screen lock method, you can protect your personal information by preventing others from accessing your device. After setting the screen lock method, the device will require an unlock code whenever unlocking it.

- **Swipe:** Swipe in any direction on the screen to unlock it.
- **Pattern:** Draw a pattern with four or more dots to unlock the screen.
- **PIN:** Enter a PIN with at least four numbers to unlock the screen.
- **Password:** Enter a password with at least four characters, numbers, or symbols to unlock the screen.
- **None:** Do not set a screen lock method.
- **Face:** Register your face to unlock the screen. Refer to [Face recognition](#) for more information.
- **Fingerprints:** Register your fingerprints to unlock the screen. Refer to [Fingerprint recognition](#) for more information.



You can set your device to perform a factory data reset if you enter the unlock code incorrectly several times in a row and reach the attempt limit. Launch the **Settings** app, tap **Lock screen** → **Secure lock settings**, unlock the screen using the preset screen lock method, and then tap the **Auto factory reset** switch to activate it.

Screen capture

Capture a screenshot while using the device and write on, draw on, crop, or share the captured screen. You can capture the current screen and scrollable area.

Use the following methods to capture a screenshot. Captured screenshots will be saved in **Gallery**.





- **Key capture:** Press and hold the Volume Down key and the Power key simultaneously.
- **Swipe capture:** Swipe your hand to the left or right across the screen.
- **Air command capture:** Hover the S Pen over the screen and press the S Pen button to open the Air command panel, and then tap **Screen write**. Refer to [Screen write](#) for more information.



- It is not possible to capture a screenshot while using some apps and features.
- If capturing a screenshot by swiping is not activated, launch the **Settings** app, tap **Advanced features** → **Motions and gestures**, and then tap the **Palm swipe to capture** switch to activate it.

After capturing a screenshot, use the following options on the toolbar at the bottom of the screen:



- : Capture the current content and the hidden content on an elongated page, such as a webpage. When you tap , the screen will automatically scroll down and more content will be captured.
- : Crop a portion from the screenshot. The cropped area will be saved in **Gallery**.
- : Write or draw on the screenshot.
- : Share the screenshot with others.



- If the options are not visible on the captured screen, launch the **Settings** app, tap **Advanced features**, and then tap the **Smart capture** switch to activate it.

Notification panel

When you receive new notifications, indicator icons appear on the status bar. To see more information about the icons, open the notification panel and view the details.

To open the notification panel, drag the status bar downwards. To close the notification panel, swipe upwards on the screen.

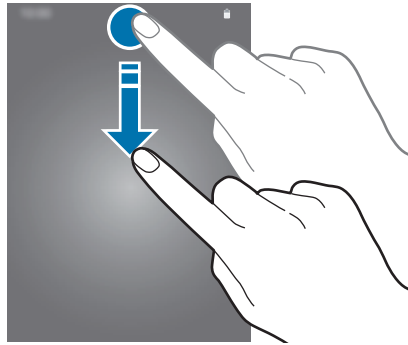

You can use the following functions on the notification panel.



Using quick setting buttons

Tap quick setting buttons to activate certain features. Swipe downwards on the notification panel to view more buttons.

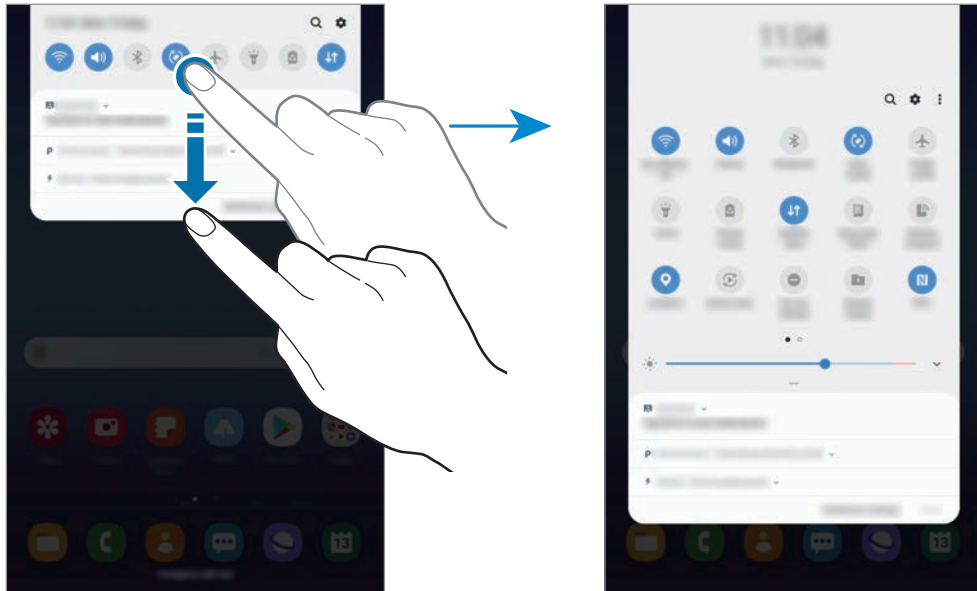

To change feature settings, tap the text under each button. To view more detailed settings, tap and hold a button.

To rearrange buttons, tap  → **Button order**, tap and hold a button, and then drag it to another location.

Entering text

Keyboard layout

A keyboard appears automatically when you enter text to send emails, create notes, and more.



Text entry is not supported in some languages. To enter text, you must change the input language to one of the supported languages.

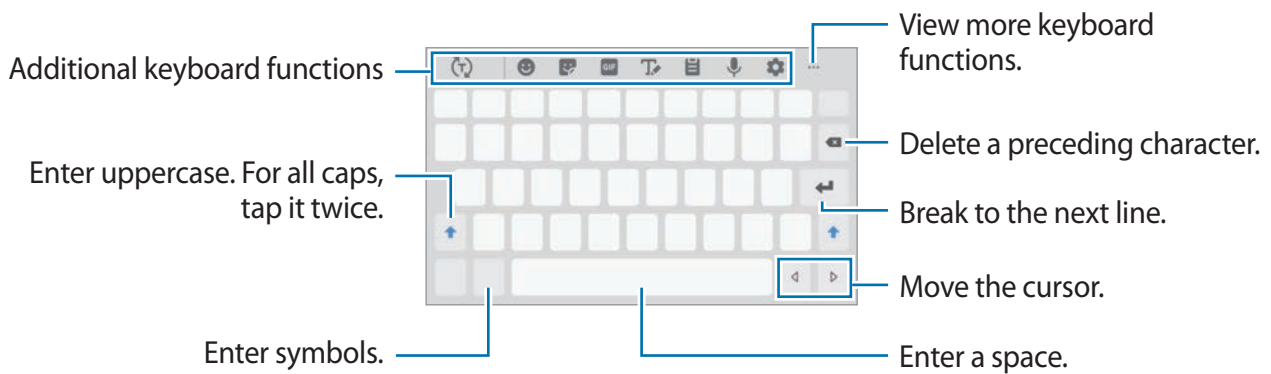







Changing the input language

Tap  → **Languages and types** → **Manage input languages**, and then select the languages to use. When you select two or more languages, you can switch between the input languages by swiping to the left or right on the space key.

Additional keyboard functions









Some features may not be available depending on the region or service provider.



- : Predict words based on your input and show word suggestions. To return to the keyboard functions list, tap .
- : Enter emoticons.
- : Enter stickers.
- : Attach animated GIFs.
- : Switch to handwriting mode.



You can quickly switch to handwriting mode by hovering the S Pen over the text field and tapping . If this feature is not activated, launch the **Settings** app, tap **Advanced features** → **S Pen**, and then tap the **Direct pen input** switch to activate it.





- : Add an item from the clipboard.
- : Enter text by voice.
- : Change the keyboard settings.
-  → : Change the keyboard mode or size.
-  → : Open the text editing panel.

Copying and pasting

- 1 Tap and hold over text.
- 2 Drag  or  to select the desired text, or tap **Select all** to select all text.
- 3 Tap **Copy** or **Cut**.
The selected text is copied to the clipboard.
- 4 Tap and hold where the text is to be inserted and tap **Paste**.
To paste text that you have previously copied, tap **Clipboard** and select the text.

Dictionary

Look up definitions for words while using certain features, such as when browsing webpages.

- 1 Tap and hold over a word that you want to look up.
If the word you want to look up is not selected, drag  or  to select the desired text.
- 2 Tap **Dictionary** on the options list.
If a dictionary is not preinstalled on the device, tap **Move to Manage dictionaries**, tap  next to a dictionary, and then tap **INSTALL** to download it.
- 3 View the definition in the dictionary pop-up window.
To switch to the full screen view, tap . Tap the definition on the screen to view more definitions. In the detailed view, tap  to add the word to your favourite words list or tap **Search Web** to use the word as a search term.

Apps and features

Installing or uninstalling apps

Galaxy Store

Purchase and download apps. You can download apps that are specialised for Samsung Galaxy devices.

Launch the **Galaxy Store** app.



This app may not be available depending on the region or service provider.

Installing apps

Browse apps by category or tap the search field to search for a keyword.

Select an app to view information about it. To download free apps, tap **INSTALL**. To purchase and download apps where charges apply, tap the price and follow the on-screen instructions.



To change the auto update settings, tap  → **Settings** → **Auto update apps**, and then select an option.

Play Store

Purchase and download apps.

Launch the **Play Store** app.

Installing apps

Browse apps by category or search for apps by keyword.

Select an app to view information about it. To download free apps, tap **INSTALL**. To purchase and download apps where charges apply, tap the price and follow the on-screen instructions.



To change the auto update settings, tap  → **Settings** → **Auto-update apps**, and then select an option.

Managing apps

Uninstalling or disabling apps

Tap and hold an app and select an option.

- **Disable:** Disable selected default apps that cannot be uninstalled from the device.
- **Uninstall:** Uninstall downloaded apps.

Enabling apps

Launch the **Settings** app, tap **Apps** → ▼ → **Disabled**, select an app, and then tap **Enable**.

Setting app permissions

For some apps to operate properly, they may need permission to access or use information on your device. When you open an app, a pop-up window may appear and request access to certain features or information. Tap **Allow** on the pop-up window to grant permissions to the app.

To view your app permission settings, launch the **Settings** app and tap **Apps**. Select an app and tap **Permissions**. You can view the app's permissions list and change its permissions.

To view or change app permission settings by permission category, launch the **Settings** app and tap **Apps** → ⋮ → **App permissions**. Select an item and tap the switches next to apps to grant permissions.



If you do not grant permissions to apps, the basic features of the apps may not function properly.

S Pen features

Air command

Air command is a menu that provides S Pen features and quick access to frequently used apps.

To open the Air command panel, hover the S Pen over the screen and press the S Pen button. You can also tap the Air command icon with the S Pen.

Drag upwards or downwards on the Air command panel and select a function or app you want.

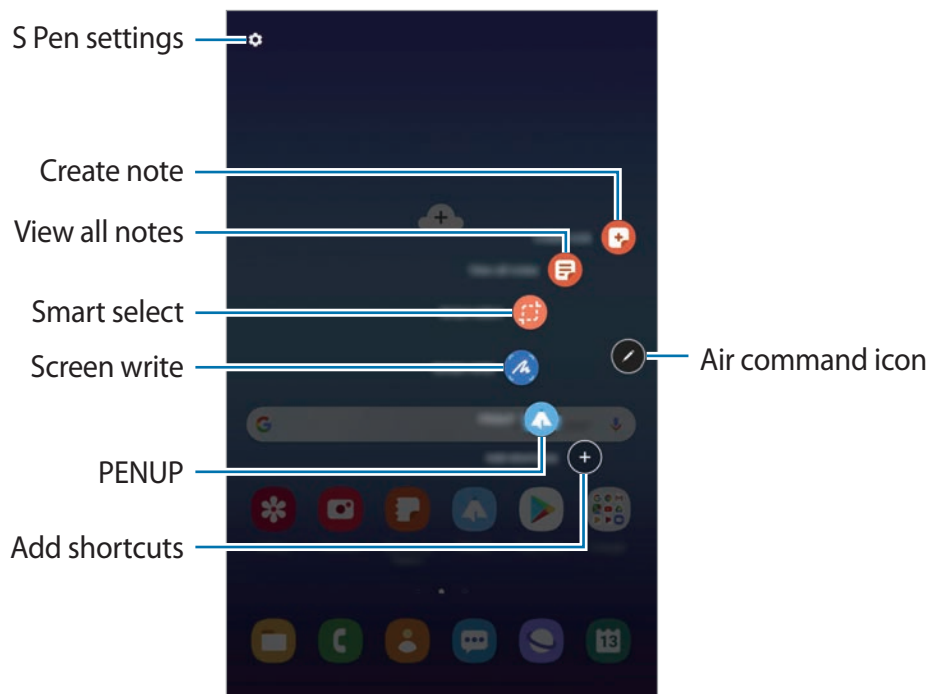

Adding shortcuts to the Air command panel

Add shortcuts to frequently used apps or functions to the Air command panel.

On the Air command panel, tap  and select apps or functions to open from the panel.

Alternatively, open the Air command panel and tap  → **Shortcuts**.

S Pen features

Activate various S Pen features from the Air command panel. The shortcuts that do not appear on the panel by default can be added by using the Add shortcuts feature.

- **Create note:** Create notes easily in a pop-up window without launching the **Samsung Notes** app. Refer to [Create note](#) for more information.
- **View all notes:** View all notes in the **Samsung Notes** app.
- **Smart select:** Use the S Pen to select an area and perform actions, such as sharing or saving. Refer to [Smart select](#) for more information.
- **Screen write:** Capture screenshots to write or draw on them or crop an area from the captured image. You can also capture the current content and the hidden content on an elongated page, such as a webpage. Refer to [Screen write](#) for more information.
- **PENUP:** Post your artwork, view others' artwork, and get useful drawing tips. Refer to [PENUP](#) for more information.
- **Glance:** Reduce an app to a thumbnail and hover the S Pen over the thumbnail to open the app in full screen view. Refer to [Glance](#) for more information.
- **Colouring:** Add colours to images provided by PENUP using the S Pen. Refer to [Colouring](#) for more information.
- **Add shortcuts:** Add shortcuts to frequently used apps to the Air command panel.

Air command icon

When the Air command panel is closed, the Air command icon will remain on the screen. You can open the Air command panel by tapping the icon with the S Pen.

To move the icon, drag  to a new location.

If the Air command icon does not appear on the screen, launch the **Settings** app, tap **Advanced features** → **S Pen**, and then tap the **Floating icon** switch to activate it.

Create note

Create notes easily in a pop-up window without launching the **Samsung Notes** app.

- 1 Open the Air command panel and tap **Create note**. Alternatively, double-tap the screen while pressing and holding the S Pen button.

The note screen will appear as a pop-up window.

- 2 Create a note using the S Pen.

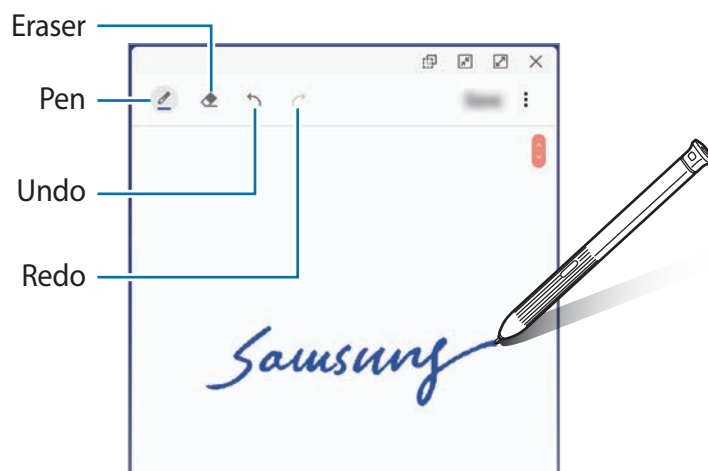

- 3 When you are finished composing the note, tap **Save**.

The note will be saved in **Samsung Notes**.





Smart select

Use the S Pen to select an area and perform actions, such as sharing or saving. You can also select an area from a video and capture it as a GIF animation.

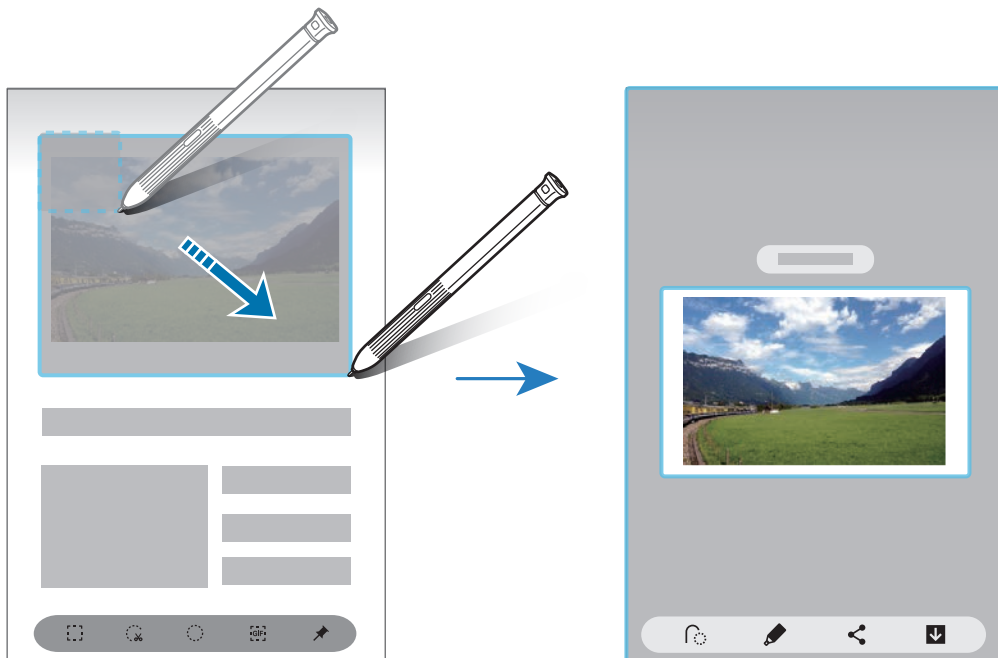
- 1 When there is content you want to capture, such as a part of an image, open the Air command panel and tap **Smart select**.
- 2 Select a desired shape icon on the toolbar and drag the S Pen across the content you want to select.

To pin the selected area at the top of the screen, tap , select the area and then tap **Pin to screen**.



- 3 Select an option to use with the selected area.
 - **Extract text:** Extract text from the selected area.
 - : Automatically changes the appearance of the selected area.
 - : Write or draw on the selected area.
 - : Share the selected area with others.
 - : Save the selected area in **Gallery**.

Capturing an area from a video

While playing a video, select an area and capture it as a GIF animation.

- 1 When there is content you want to capture during video playback, open the Air command panel and tap **Smart select**.
- 2 On the toolbar, tap .
- 3 Adjust the position and size of the capturing area.

Adjust the position.

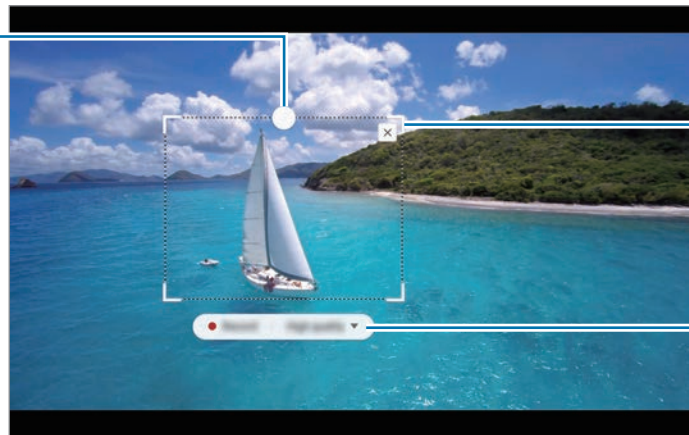

Drag a corner of the frame to resize.

Select a quality.





- 4 Tap **Record** to start capturing.



- Before capturing a video, make sure that the video is playing.
- The maximum duration you can capture an area of the video for will be displayed on the screen.
- When capturing an area from a video, its sound will not be recorded.

- 5 Tap **Stop** to stop capturing.

- 6 Select an option to use with the selected area.

- : Write or draw on the selected area. Tap  to view the result before saving the file.
- : Share the selected area with others.
- : Save the selected area in **Gallery**.

Screen write

Capture screenshots to write or draw on them or crop an area from the captured image.



It is not possible to capture a screenshot while using some apps.

- 1 When there is content you want to capture, open the Air command panel and tap **Screen write**.

The current screen is automatically captured and the editing toolbar appears.

- 2 If you capture the content on an elongated page, such as a webpage, tap **Scroll capture** to capture the hidden content. Tap **Capture more** repeatedly until screen capture is complete, and then tap **Done**.

- 3 Write a memo on the screenshot.

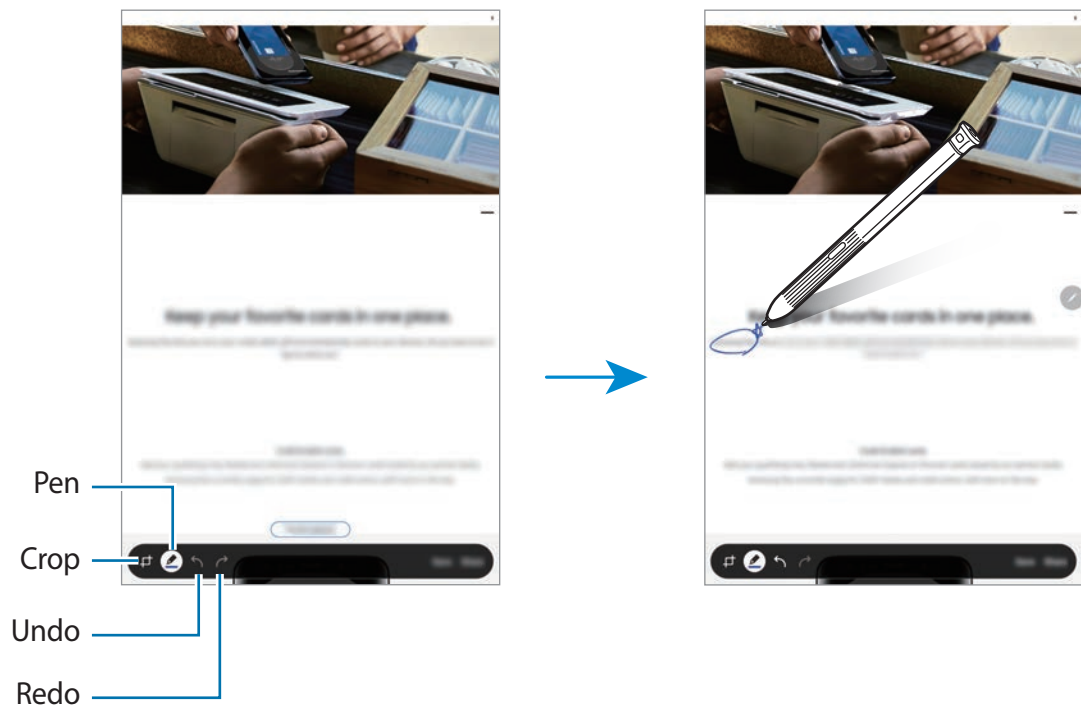

4 Select an option to use with the screenshot.

- **Save:** Save the screenshot in **Gallery**.
- **Share:** Share the screenshot with others.

Glance

Reduce an app to a thumbnail and hover the S Pen over the thumbnail to open the app in full screen view.

For example, launch a map app, open the Air command panel, and then tap **Glance**. The app will be reduced to a thumbnail at the bottom of the screen. While browsing webpages, hover the S Pen over the thumbnail to open the map app on the full screen and quickly search for places.

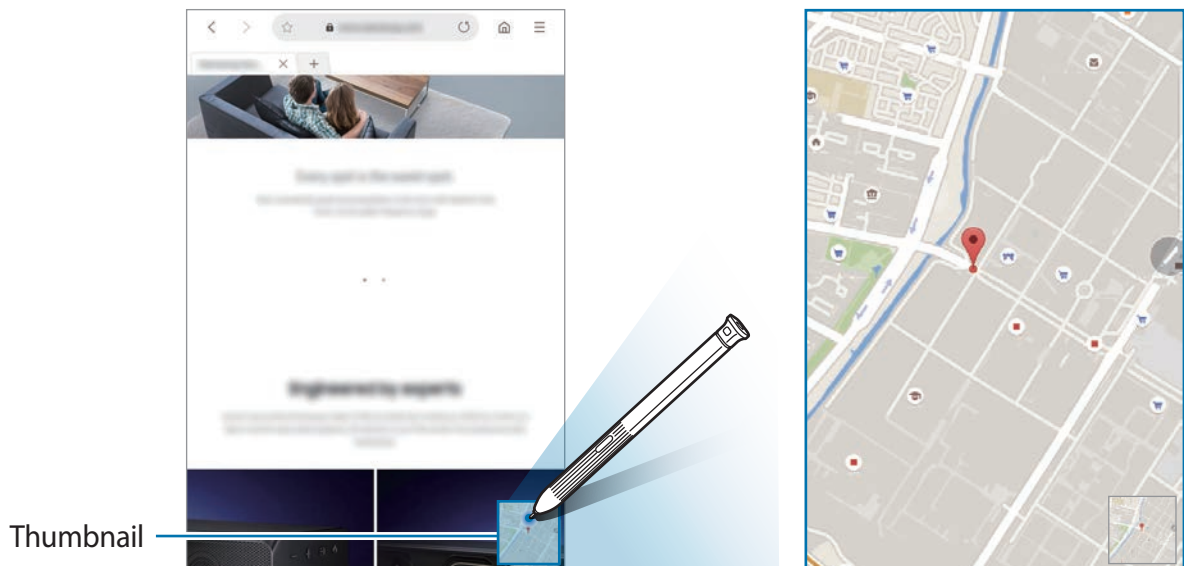

Hover the S Pen away from the screen to reduce the app to a thumbnail again.

To close the minimised app, tap and hold the thumbnail and drag it to **Remove** at the top of the screen.

Colouring

You can colour images provided by PENUP. Using the various colours, create your own artwork.

Open the Air command panel, tap **Colouring**, select an image, and then start colouring the image. When you are finished, save the image to **Gallery** or post it to PENUP.

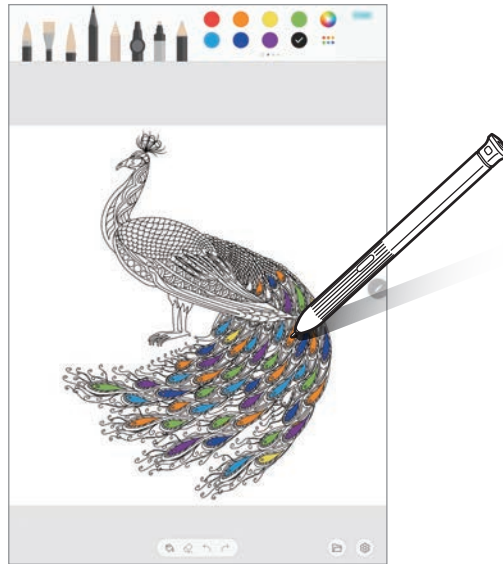

Air view

Hover the S Pen over an item on the screen to preview content or view information in a pop-up window.

In some apps, Action buttons will be displayed on the preview window.

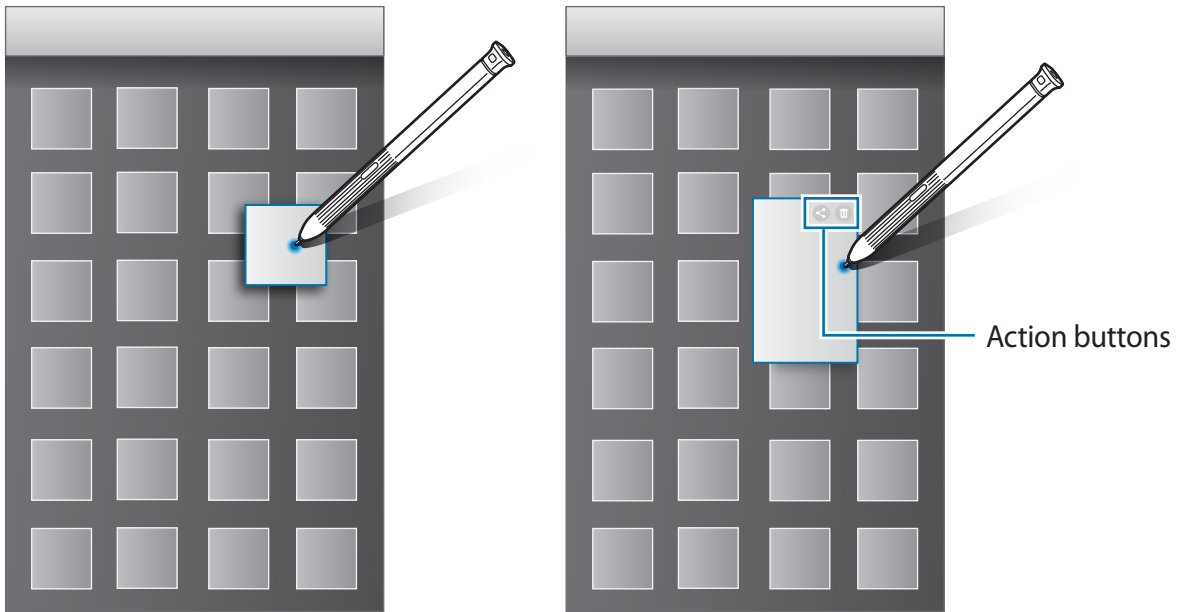

If this feature is not activated, launch the **Settings** app, tap **Advanced features** → **S Pen**, and then tap the **Air view** switch to activate it.

Pen Select

While pressing and holding the S Pen button, drag the S Pen over text or item lists to select multiple items or text. You can also copy and paste the selected items or text into another app or share them with others.

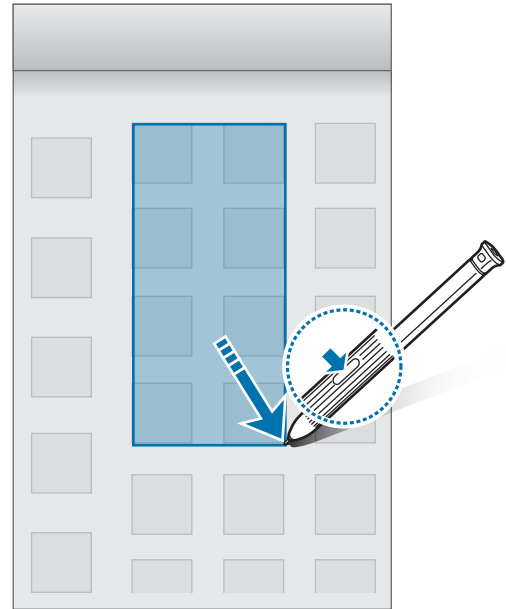
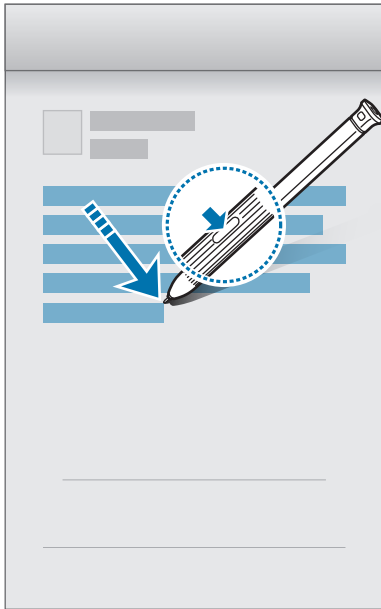

Direct pen input

Fill in forms and write messages using your handwriting with the S Pen.

- 1 Hover the S Pen over a text field.
- 2 Tap  to open the handwriting field.



- 3 Write with the S Pen.



If this feature is not activated, launch the **Settings** app, tap **Advanced features** → **S Pen** → **Direct pen input**, and then tap the switch to activate it.



Screen off memo

You can quickly create memos by writing on the screen without turning on it.



If this feature is not activated, launch the **Settings** app, tap **Advanced features** → **S Pen**, and then tap the **Screen off memo** switch to activate it.

Creating a screen off memo



- 1 When the screen is off, hover the S Pen over the screen and press the S Pen button.
- 2 Write or draw a memo.
To extend the page, tap .
- 3 To save the memo, tap **Save in Notes**. The memo will be saved to **Samsung Notes** →  → **Screen off memo**.

Phone (SM-T395)

Introduction

Make or answer voice and video calls.

Making calls

- 1 Launch the **Phone** app and tap **Keypad**.
- 2 Enter a phone number.
- 3 Tap  to make a voice call, or tap  to make a video call.

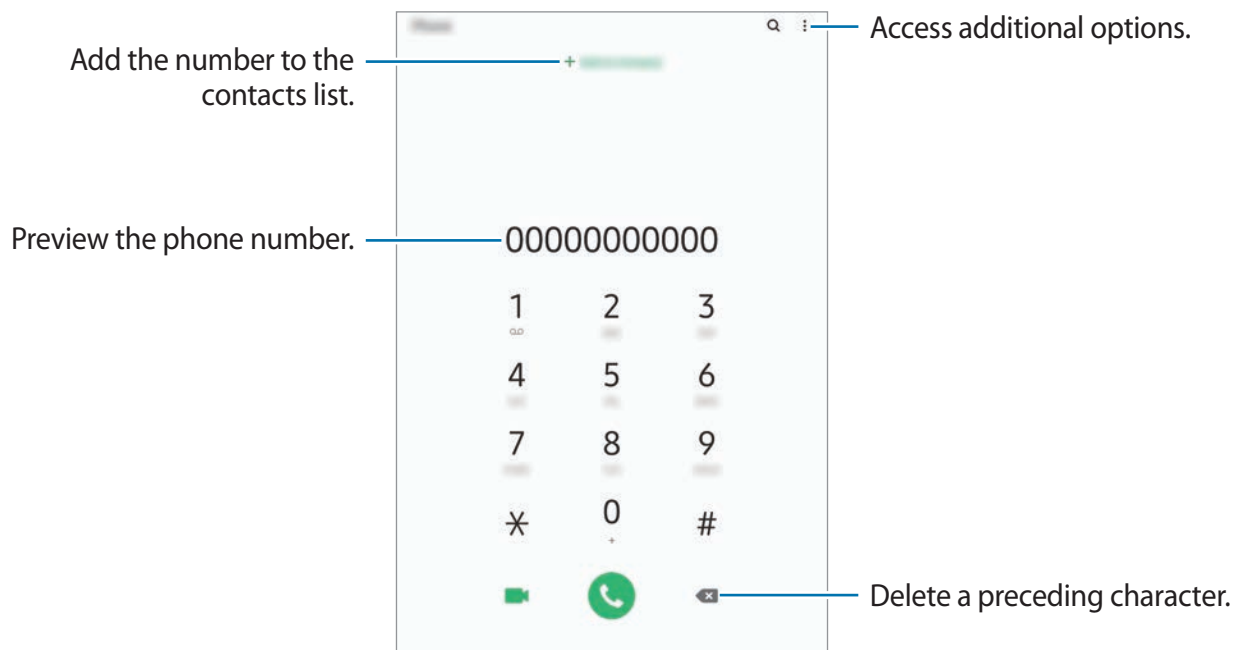

Making calls from call logs or contacts list

Tap **Recents** or **Contacts**, and then swipe to the right on a contact or a phone number to make a call.

If this feature is deactivated, launch the **Settings** app, tap **Advanced features** → **Motions and gestures**, and then tap the **Swipe to call or send messages** switch to activate it.

Using speed dial

Set speed dial numbers to quickly make calls.

To set a number to speed dial, tap **Keypad** or **Contacts** →  → **Speed dial numbers**, select a speed dial number, and then add a phone number.

To make a call, tap and hold a speed dial number on the keypad. For speed dial numbers 10 and up, tap the first digit(s) of the number, and then tap and hold the last digit.

For example, if you set the number **123** as a speed dial number, tap **1**, tap **2**, and then tap and hold **3**.

Making calls from the locked screen

On the locked screen, drag  outside the circle.

Making an international call

- 1 Launch the **Phone** app and tap **Keypad**.
- 2 Tap and hold **0** until the + sign appears.
- 3 Enter the country code, area code, and phone number, and then tap .

Receiving calls



Answering a call

When a call comes in, drag  outside the large circle.

Rejecting a call

When a call comes in, drag  outside the large circle.

To send a message when rejecting an incoming call, drag the **Send message** bar upwards. If the **Add reminder** switch is activated, a reminder will be saved to alert you of the rejected call one hour later.

To create various rejection messages, launch the **Phone** app, tap  → **Settings** → **Quick decline messages**, enter a message, and then tap .

Missed calls

If a call is missed, the  icon appears on the status bar. Open the notification panel to view the list of missed calls. Alternatively, launch the **Phone** app and tap **Recents** to view missed calls.

Blocking phone numbers

Block calls from specific numbers added to your block list.

1 Launch the **Phone** app and tap  → **Settings** → **Block numbers**.

2 Tap **Recents** or **Contacts**, select contacts, and then tap **Done**.

To manually enter a number, tap **Add phone number**, enter a phone number, and then tap .

When blocked numbers try to contact you, you will not receive notifications. The calls will be logged in the call log.





You can also block incoming calls from people that do not show their caller ID. Tap the **Block unknown callers** switch to activate the feature.

Options during calls



During a voice call

The following actions are available:

- : Access additional options.
- **Add call:** Dial a second call. The first call will be put on hold. When you end the second call, the first call will be resumed.
- **Hold call:** Hold a call. Tap **Resume call** to retrieve the held call.
- **Bluetooth:** Switch to a Bluetooth headset if it is connected to the device.
- **Speaker:** Activate or deactivate the speakerphone. When using the speakerphone, keep the device away from your ears.
- **Mute:** Turn off the microphone so that the other party cannot hear you.
- **Keypad / Hide:** Open or close the keypad.
- : End the current call.

During a video call

Tap the screen to use the following options:

- : Access additional options.
- **Camera:** Turn off the camera so that the other party cannot see you.
- **Switch:** Switch between the front and rear cameras.
- : End the current call.
- **Mute:** Turn off the microphone so that the other party cannot hear you.
- **Speaker:** Activate or deactivate the speakerphone. When using the speakerphone, keep the device away from your ears.

Adding a phone number to Contacts

Adding a phone number to Contacts from the keypad

- 1 Launch the **Phone** app and tap **Keypad**.
- 2 Enter the number.
- 3 Tap **Add to Contacts**.
- 4 Tap **Create contact** to create a new contact, or tap **Update existing** to add the number to an existing contact.

Adding a phone number to Contacts from the calls list

- 1 Launch the **Phone** app and tap **Recents**.
- 2 Tap a phone number → **Add**.
- 3 Tap **Create contact** to create a new contact, or tap **Update existing** to add the number to an existing contact.

Adding a tag to a phone number

You can add tags to numbers without saving them to Contacts. This allows you to view the caller's information when they call without having them listed in Contacts.

- 1 Launch the **Phone** app and tap **Recents**.
- 2 Tap the contact.
- 3 Tap **Add tag**, enter a tag, and then tap **Add**.
When a call comes from that number, the tag will show under the number.

Contacts

Introduction

Create new contacts or manage contacts on the device.

Adding contacts

Creating a new contact

- 1 Launch the **Contacts** app and tap .
- 2 Select a storage location and tap **Select**.
- 3 Enter contact information.

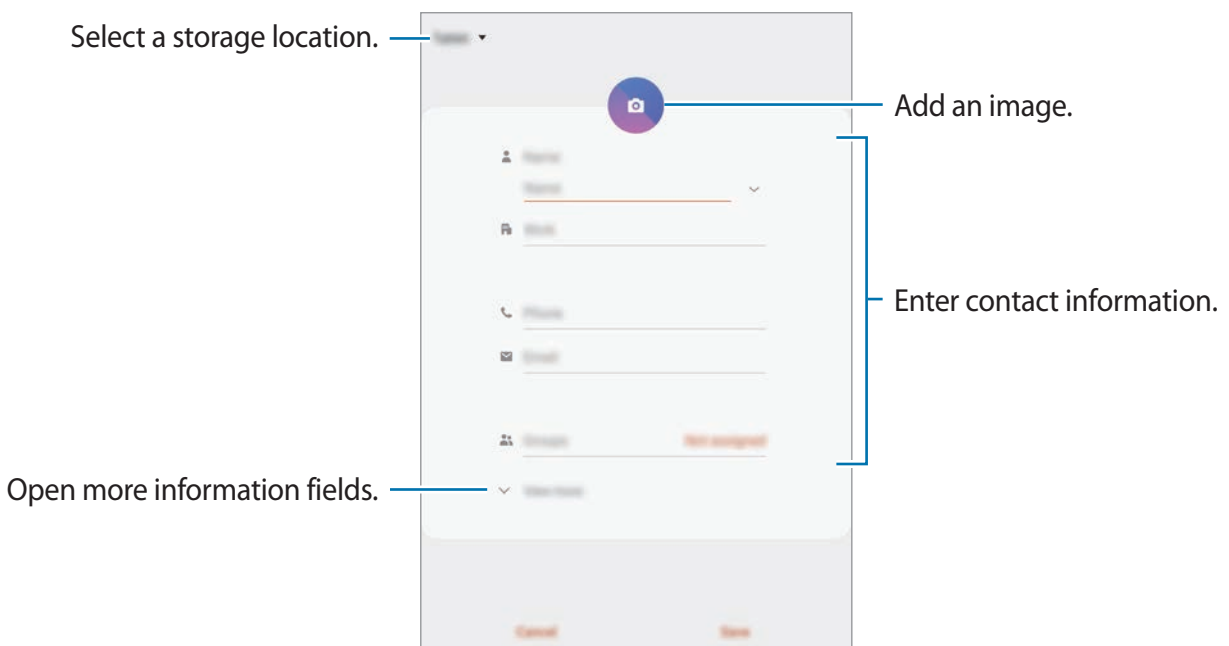

Depending on the selected storage location, the types of information you can save may vary.

- 4 Tap **Save**.

Importing contacts

Add contacts by importing them from other storages to your device.

- 1 Launch the **Contacts** app and tap  → **Manage contacts** → **Import/export contacts** → **Import**.
- 2 Select a storage location to import contacts from.
- 3 Tick VCF files or contacts to import and tap **Done**.
- 4 Select a storage location to save contacts to and tap **Import**.

Syncing contacts with your web accounts

Sync your device contacts with online contacts saved in your web accounts, such as your Samsung account.

- 1 Launch the **Settings** app, tap **Accounts and backup** → **Accounts** and select the account to sync with.
- 2 Tap **Sync account** and tap the **Contacts** switch to activate it.
For the Samsung account, tap  → **Sync settings** and tap the **Contacts** switch to activate it.

Searching for contacts

Launch the **Contacts** app.

Use one of the following search methods:

- Scroll up or down the contacts list.
- Drag a finger along the index at the right side of the contacts list to scroll through it quickly.
- Tap **Q** at the top of the contacts list and enter search criteria.

Tap the contact. Then take one of the following actions:

- ☆ : Add to favourite contacts.
- 📞 / 📺 : Make a voice or video call.



This feature may not be available depending on the model.

- 💬 : Compose a message.



This feature may not be available depending on the model.

- ✉️ : Compose an email.

Sharing contacts

You can share contacts with others by using various sharing options.

- 1 Launch the **Contacts** app and tap  → **Share**.
- 2 Select contacts and tap **Share**.
- 3 Select a sharing method.

Saving and sharing profile (SM-T395)

Save and share your profile information, such as your photo and status message, with others using the profile sharing feature.



- The profile sharing feature may not be available depending on the region or service provider.
- The profile sharing feature is only available for contacts who have activated the profile sharing feature on their device.

- 1 Launch the **Contacts** app and select your profile.
- 2 Tap **Edit**, edit your profile, and tap **Save**.

3 Tap **Tap here to share your profile** and tap the switch to activate it.

To use the profile sharing feature, your phone number must be verified. You can view your contacts' updated profile information in **Contacts**.

To change the scope of contacts to share your profile with, tap **Select what's shared**, select an item to share, and then select an option.

Creating groups

You can add groups, such as family or friends, and manage contacts by group.

1 Launch the **Contacts** app and tap  → **Groups** → **Create group**.

2 Enter a group name.

To set a group ringtone, tap **Group ringtone** and select a ringtone. (SM-T395)

3 Tap **Add member**, select contacts to add to the group, and then tap **Done**.

4 Tap **Save**.

Sending a group message

You can send a group message to a group's members at the same time.

Launch the **Contacts** app, tap  → **Groups**, select a group, and then tap  → **Send message**.

Merging duplicate contacts

When you import contacts from other storages, or sync contacts with other accounts, your contacts list may include duplicate contacts. Merge duplicate contacts into one to streamline your contacts list.

- 1 Launch the **Contacts** app and tap  → **Manage contacts** → **Merge contacts**.
- 2 Tick contacts and tap **Merge**.

Deleting contacts

- 1 Launch the **Contacts** app and tap  → **Delete**.
- 2 Select contacts and tap **Delete**.

To delete contacts one by one, open the contacts list and tap a contact. Then tap  → **Delete**.

Messages (SM-T395)

Introduction

Send and view messages by conversation.

Sending messages



You may incur additional charges for sending messages when you are roaming.

1 Launch the **Messages** app and tap .

2 Add recipients and enter a message.

To record and send a voice message, tap and hold , say your message, and then release your finger. The recording icon appears only while the keyboard is hidden.

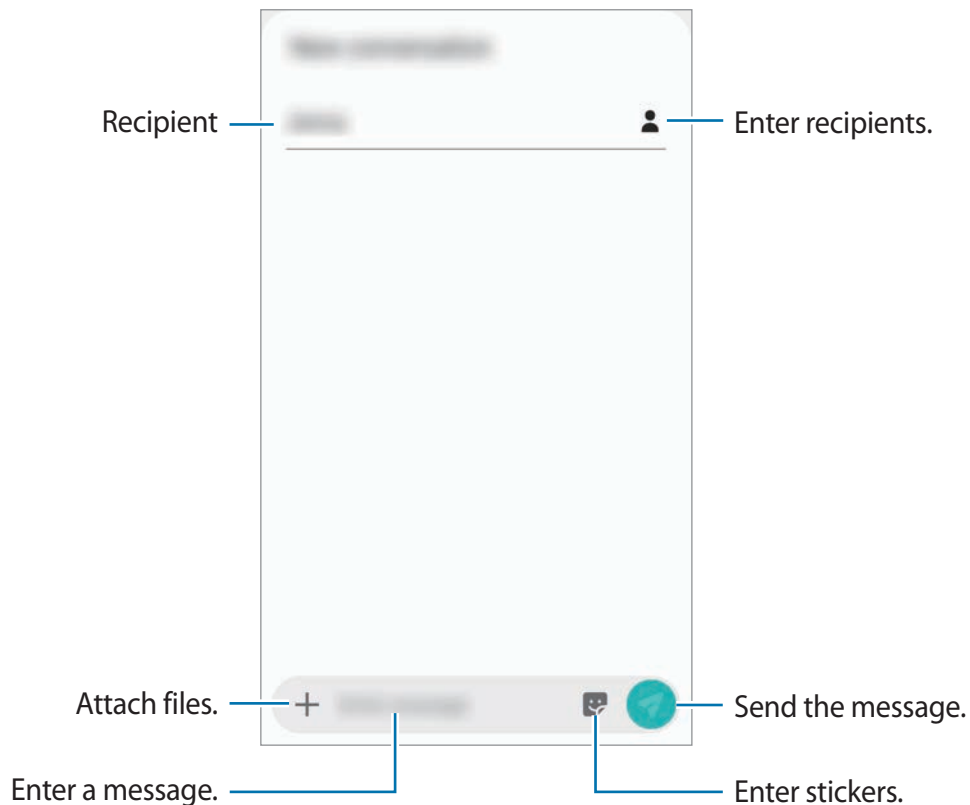

- 3 Tap  to send the message.

Viewing messages

Messages are grouped into message threads by contact.





You may incur additional charges for receiving messages when you are roaming.

- 1 Launch the **Messages** app and tap **Conversations**.
- 2 On the messages list, select a contact.
- 3 View your conversation.
To reply to the message, tap **Enter message**, enter a message, and then tap .
To adjust the font size, spread two fingers apart or pinch on the screen.

Blocking unwanted messages

Block messages from specific numbers added to your block list.

- 1 Launch the **Messages** app and tap  → **Settings** → **Block numbers and messages** → **Block numbers**.
- 2 Tap **Inbox** and select a contact. Or, tap **Contacts**, select contacts, and then tap **Done**.
To manually enter a number, enter a phone number under **Enter number** and tap .

Setting the message notification

You can change notification sound, display options, and more.

- 1 Launch the **Messages** app, tap **⋮** → **Settings** → **Notifications**, and then tap the switch to activate it.
- 2 Change the notification settings.

Setting a message reminder

You can set an alert at an interval to let you know that you have unchecked notifications. If this feature is not activated, launch the **Settings** app, tap **Accessibility** → **Advanced settings** → **Notification reminders**, and then tap the switch to activate it.

Deleting messages

- 1 Launch the **Messages** app and tap **Conversations**.
- 2 On the messages list, select a contact.
- 3 Tap and hold a message, tap **Delete**.
To delete multiple messages, tick messages you want to delete.
- 4 Tap **Delete**.

Internet

Introduction

Browse the Internet to search for information and bookmark your favourite webpages to access them conveniently.

Browsing webpages

- 1 Launch the **Internet** app.
- 2 Tap the address field.
- 3 Enter the web address or a keyword, and then tap **Go**.

To view the toolbars, drag your finger downwards slightly on the screen.

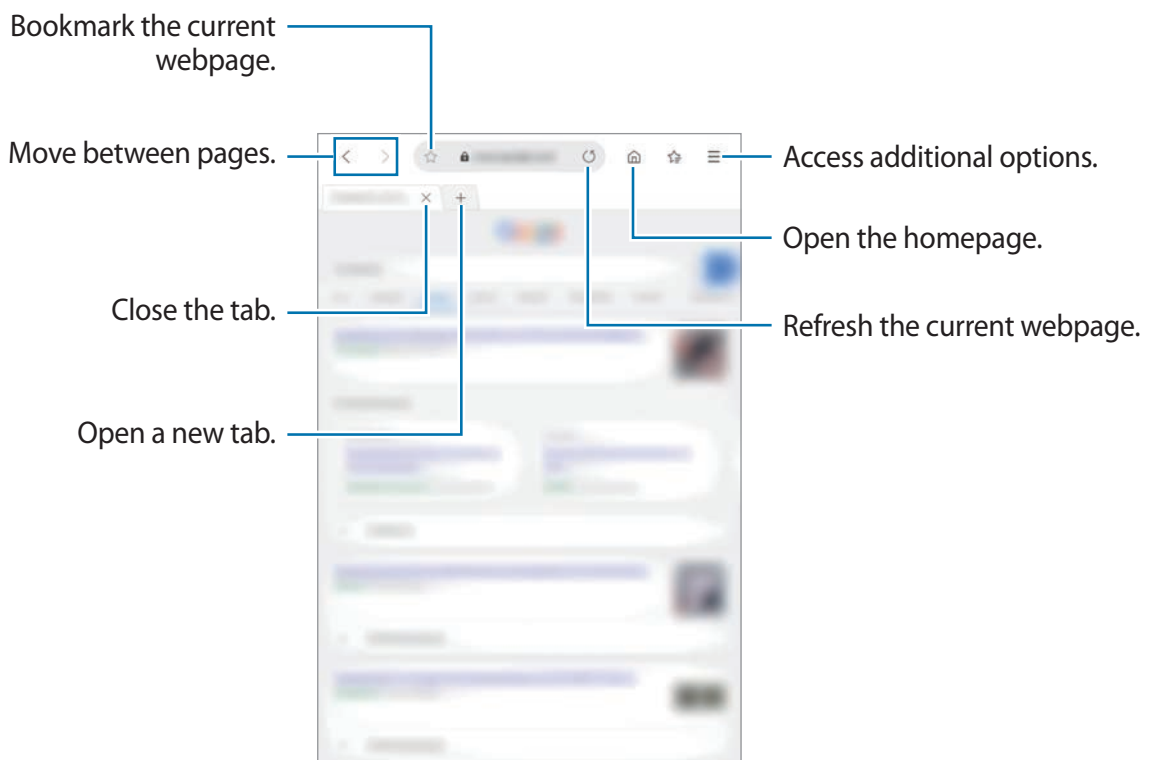

Using secret mode

In secret mode, you can separately manage open tabs, bookmarks, and saved pages. You can lock secret mode using a password and your biometric data.

Activating secret mode

Tap  → **Turn on Secret mode**. If you are using this feature for the first time, set whether to use a password for secret mode.

In secret mode, the device will change the colour of the toolbars.



In secret mode, you cannot use some features, such as screen capture.

Changing security settings

You can change your password or the lock method.

Tap  → **Settings** → **Privacy and security** → **Secret mode settings** → **Change password**.

To set your registered biometric data as the lock method along with the password, tap the **Fingerprints** switch to activate it. Refer to [Fingerprint recognition](#) for more information about using your biometric data.

Deactivating secret mode



Tap  → **Turn off Secret mode**.



Email

Setting up email accounts



Set up an email account when opening **Email** for the first time.

- 1 Launch the **Email** app.
- 2 On the list, select an email service or tap **Other**.
- 3 Follow the on-screen instructions to complete the setup.

To set up another email account, tap  →  → **Add account**.

If you have more than one email account, you can set one as the default account. Tap  →  →  → **Set default account**.

Sending emails



- 1 Tap  to compose an email.
- 2 Add recipients and enter a subject line and text.
- 3 Tap  to send the email.

Reading emails

When **Email** is open, the device will automatically retrieve new emails. To manually retrieve emails, swipe downwards on the top of the emails list.

Tap an email on the screen to read it.



If email syncing is disabled, new emails cannot be retrieved. To enable email syncing, tap  →  → your account name, and then tap the **Sync account** switch to activate it.

Camera

Introduction

Take photos and record videos using various modes and settings.

Camera etiquette

- Do not take photos or record videos of other people without their permission.
- Do not take photos or record videos where legally prohibited.
- Do not take photos or record videos in places where you may violate other people's privacy.

Launching Camera

Launch the **Camera** app.



- Some methods may not be available depending on the region or service provider.
- If photos you take appear blurry, clean the camera lens and try again.
- If the device and external environment have significantly different temperature, humidity can accumulate in the Camera window. To remove moisture quickly, remove the back cover and replace it.



Basic shooting

Taking photos or recording videos

- 1 On the shooting modes list, tap **Photo** or **Video**.
- 2 Tap the image on the preview screen where the camera should focus.

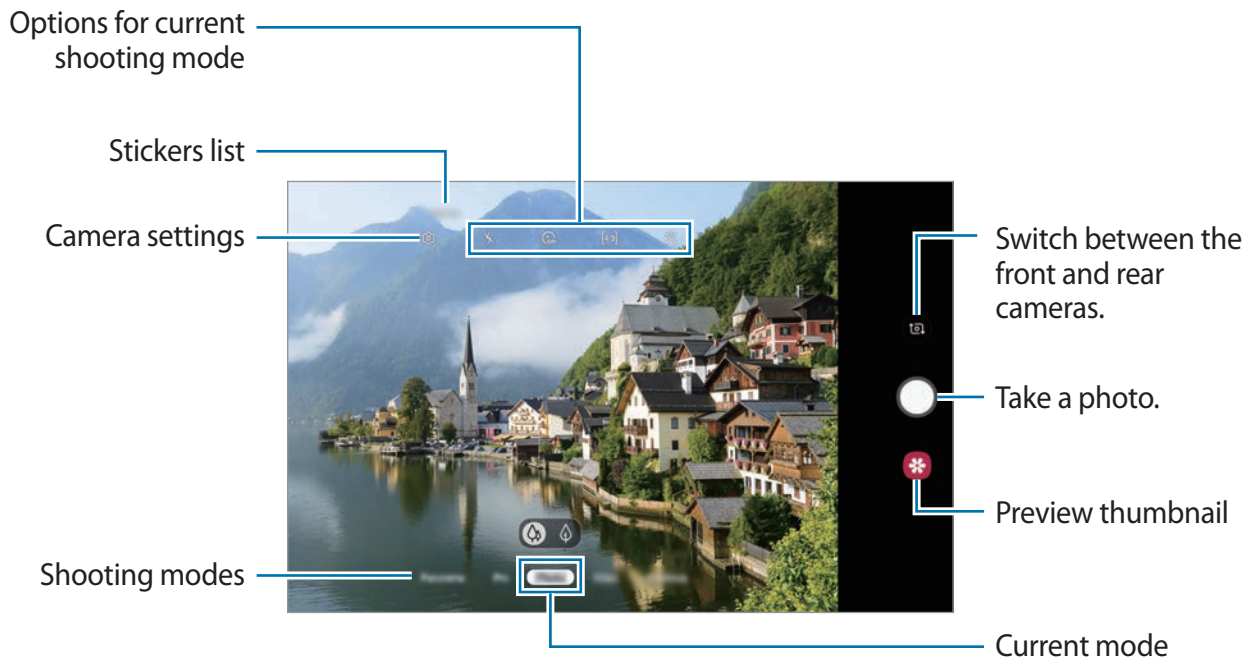
3 Tap  to take a photo or tap  to record a video.



- To adjust the brightness of photos or videos, tap the screen. When the adjustment bar appears, drag  on the adjustment bar towards **+** or **-**.
- To capture an image from the video while recording, tap .
- To change the focus while recording a video, tap where you want to focus. To use auto focus mode, tap .



- The preview screen may vary depending on the shooting mode and which camera is being used.
- The camera automatically shuts off when unused.
- Make sure that the lens is not damaged or contaminated. Otherwise, the device may not work properly in some modes that require high resolutions.
- Your device's camera features a wide-angle lens. Minor distortion may occur in wide-angle photos or videos and does not indicate device performance problems.

Zooming in and out

Spread two fingers apart on the screen to zoom in, and pinch to zoom out.



- Zooming features are available only when using the rear camera.
- The 2x optical zoom may not work in low-light environments.

Using the focus and exposure features

You can lock the focus or exposure on a selected area to prevent the camera from automatically adjusting based on changes to the subjects or light sources.

Tap and hold the area to focus, the AF/AE frame will appear on the area and the focus and exposure setting will be locked. The setting remains locked even after you take a photo.



This feature is available only in **Photo** or **Pro** modes.

Using shooting modes

To change the shooting mode, drag the shooting modes list to the left or right, or swipe to the left or right on the preview screen.

Select a shooting mode you want.





You can edit the shooting modes list. On the preview screen, tap  → **Camera modes** → **Edit modes**. Alternatively, tap and hold the shooting modes list on the preview screen.

Photo mode

The camera adjusts the shooting options automatically based on the surroundings to capture photos easily.

On the shooting modes list, tap **Photo**.

To take self-portraits with the front camera, swipe upwards or downwards, or tap  to switch to the front camera.

Applying beauty effects

You can select a filter effect and also modify your facial features, such as your skin tone or face shape, before taking a self-portrait.

- 1 On the preview screen, tap .
- 2 Select a filter effect or beauty effects and take a photo.



Video mode

The camera adjusts the shooting options automatically based on the surroundings to record videos easily.

On the shooting modes list, tap **Video**.

Live focus mode

Take selfies that focus on your face by blurring the background.

- 1 On the preview screen, swipe upwards or downwards, or tap  to switch to the front camera for self-portraits.
- 2 On the shooting modes list, tap **Live focus**.
- 3 Face the front camera lens.
- 4 When **Effect ready.** appears on the preview screen, tap  to take a photo.
Alternatively, show your palm to the front camera. After recognising your palm, a countdown timer will appear. When the time is up, the device will take a photo.





To use various shooting options for the front camera, tap  → **Shooting methods**, and then tap the switches to activate them.

Pro mode

Capture photos while manually adjusting various shooting options, such as exposure value and ISO value.

On the shooting modes list, tap **Pro**. Select options and customise the settings, and then tap  to take a photo.

Available options

-  : Select an ISO value. This controls camera light sensitivity. Low values are for stationary or brightly lit objects. Higher values are for fast-moving or poorly lit objects. However, higher ISO settings can result in noise in photos.
-  : Select an appropriate white balance, so images have a true-to-life colour range. You can set the colour temperature.
-  : Change the exposure value. This determines how much light the camera's sensor receives. For low-light situations, use a higher exposure.



Panorama mode

Using panorama mode, take a series of photos and then stitch them together to create a wide scene.



To get the best shots using panorama mode, follow these tips:

- Move the camera slowly in one direction.
- Keep the image within the frame on the camera's viewfinder. If the preview image is out of the guide frame or you do not move the device, the device will automatically stop taking photos.
- Avoid taking photos of indistinct backgrounds, such as an empty sky or a plain wall.

- 1 On the shooting modes list, tap **Panorama**.
- 2 Tap  and move the device slowly in one direction.
- 3 Tap  to stop taking photos.

HDR mode

Take photos with rich colours and reproduce details even in bright and dark areas.

On the shooting modes list, tap **HDR**.



Without effect



With effect

Night mode

Take a photo in low-light conditions, without using the flash.

On the shooting modes list, tap **Night**.



You must first add this mode to the shooting modes list before you can use it. On the preview screen, tap  → **Camera modes** → **Edit modes**, and then tick **Night**.

Continuous shot mode

Take a series of photos of moving subjects.

On the shooting modes list, tap **Continuous shot**.

Tap and hold  to take several photos continuously.

Animated GIF mode

Create an animated photo from a series of photos.

On the shooting modes list, tap **Animated GIF**.



You must first add this mode to the shooting modes list before you can use it. On the preview screen, tap  → **Camera modes** → **Edit modes**, and then tick **Animated GIF**.

Sports mode

Take clearer photos of fast-moving subjects, such as a person running or a pet in motion.



On the shooting modes list, tap **Sports**.



You must first add this mode to the shooting modes list before you can use it. On the preview screen, tap  → **Camera modes** → **Edit modes**, and then tick **Sports**.

Wide selfie mode

Take a wide self-portrait and include as many people in the photo as possible to avoid leaving people out.

- 1 On the preview screen, swipe upwards or downwards, or tap  to switch to the front camera for self-portraits.
- 2 On the shooting modes list, tap **Wide selfie**.
- 3 Face the front camera lens.
- 4 Tap  to take a photo.

Alternatively, show your palm to the front camera. After recognising your palm, a countdown timer will appear. When the time is up, the device will take a photo.



To use various shooting options for the front camera, tap  → **Shooting methods**, and then tap the switches to activate them.

- 5 Slowly swivel the device left and then right or vice versa to take a wide self-portrait. The device will take additional photos when the white frame moves to each end of the viewfinder window.



- Make sure to keep the white frame inside the viewfinder window.
- The subjects should remain still while taking wide self-portraits.
- The top and bottom parts of the image displayed on the preview screen may be cut out of the photo depending on the shooting conditions.





Customising camera settings





Options for current shooting mode

On the preview screen, use the following options.



The available options may vary depending on the shooting mode.

-  : Activate or deactivate the flash.
-  : Select the length of the delay before the camera automatically takes a photo.
-  : Select an aspect ratio for photos.
-  : Apply beauty effects or a filter effect.
-  : Select an aspect ratio for videos.

- : Select a metering method. This determines how light values are calculated.  **Centre-weighted** uses the light in the centre portion of the shot to calculate the exposure of the shot.  **Spot** uses the light in a concentrated centre area of the shot to calculate the exposure of the shot.  **Matrix** averages the entire scene.

Camera settings

On the preview screen, tap . Some options may not be available depending on the shooting mode.

Pictures

- **Rear picture size:** Select a resolution for photos you want to take with the rear camera. Using a higher resolution will result in higher quality photos, but they will take up more memory.
- **Front picture size:** Select a resolution for photos you want to take with the front camera. Using a higher resolution will result in higher quality photos, but they will take up more memory.

Videos

- **Rear video size:** Select a resolution for videos you want to take with the rear camera. Using a higher resolution will result in higher quality videos, but they will take up more memory.
- **Front video size:** Select a resolution for videos you want to take with the front camera. Using a higher resolution will result in higher quality videos, but they will take up more memory.
- **High efficiency video:** Activate the High efficiency video feature, you can record videos in the High Efficiency Video Codec (HEVC) format. Your HEVC videos will be saved as compressed files to conserve the device's memory.



You cannot play the HEVC videos on other devices or share them online.

Useful features

- **Grid lines:** Display viewfinder guides to help composition when selecting subjects.
- **Location tags:** Attach a GPS location tag to the photo.
 -  GPS signal strength may decrease in locations where the signal is obstructed, such as between buildings or in low-lying areas, or in poor weather conditions.
 - Your location may appear on your photos when you upload them to the Internet. To avoid this, deactivate the location tag setting.
- **Camera modes:** View available shooting modes or edit the shooting modes list.
- **Shooting methods:** Select a shooting method for taking a photo or recording a video.
- **Storage location:** Select the memory location for storage. This feature will appear when you insert a memory card.
- **Quick review:** Set the device to show photos after capturing them.
- **Full screen view (16:9):** Set the device to preview photos or videos using the full screen ratio.
- **Pictures as previewed (Selfie):** Invert the image to create a mirror-image of the original scene, when taking photos with the front camera.
- **Reset settings:** Reset the camera settings.
- **Contact us:** Ask questions or view frequently asked questions. Refer to [Samsung Members](#) for more information.
- **About Camera:** View the Camera app version and legal information.

Gallery

Introduction

View images and videos stored in your device. You can also manage images and videos by album or create stories.

Viewing images

- 1 Launch the **Gallery** app and tap **Pictures**.
- 2 Select an image.

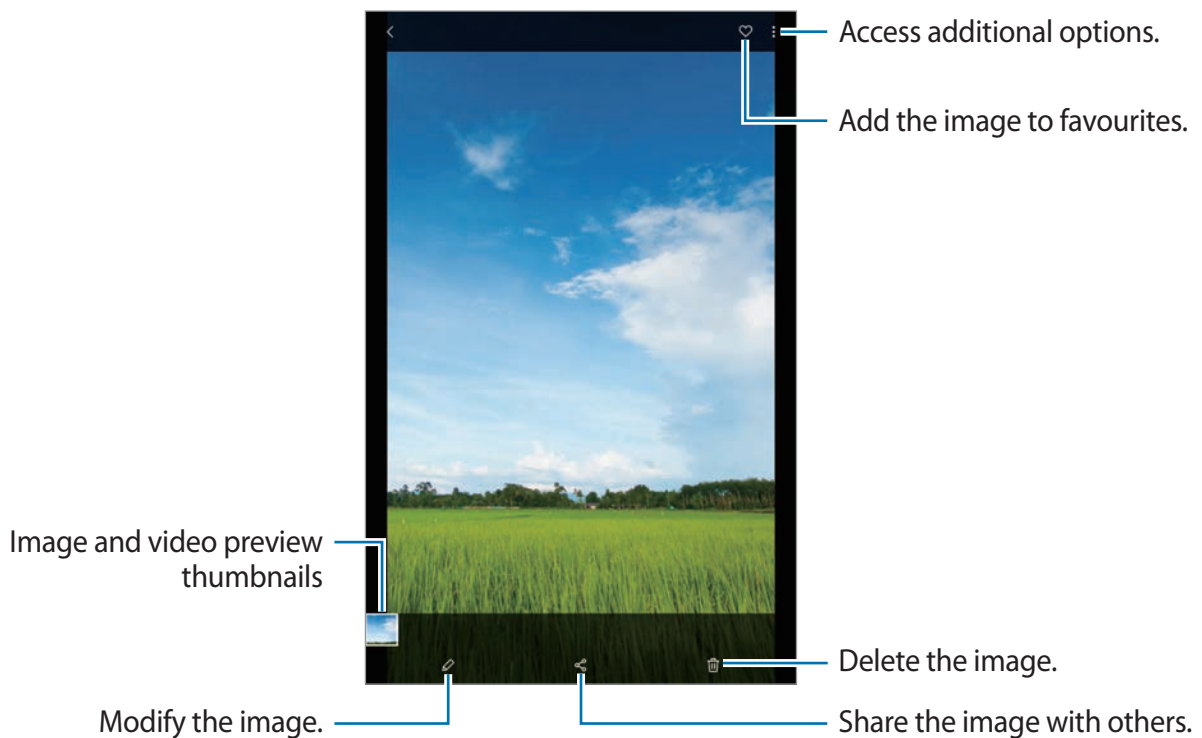

You can create an animated GIF or collage from multiple images. On the list, tap **⋮** → **Create GIF** or **Create collage**, and then select images.

Searching for images

Launch the **Gallery** app and tap **🔍** to view images sorted by category, such as types, locations, or documents.

To search for images by entering keywords, tap the search field.

Viewing videos

- 1 Launch the **Gallery** app and tap **Pictures**.
- 2 Select a video to play.
- 3 Tap **Play video** to play the video.

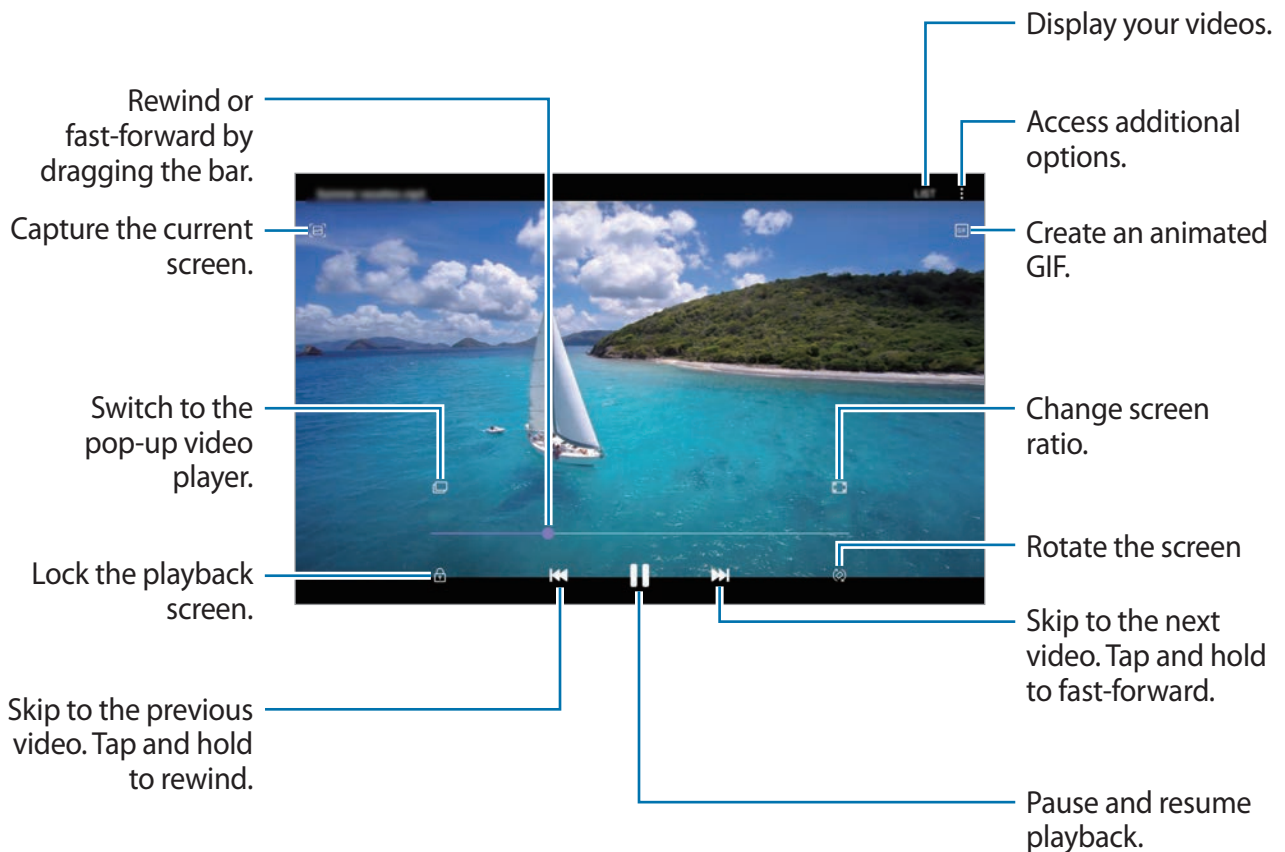

Drag your finger up or down on the left side of the playback screen to adjust the brightness, or drag your finger up or down on the right side of the playback screen to adjust the volume. To rewind or fast-forward, swipe to the left or right on the playback screen.

Viewing the details of images and videos

You can view file details, such as people, location, and basic information. If there is auto created content, such as a story or a GIF, the content will also be displayed.

While viewing an image or on the video preview screen, drag upwards on the screen. File details will appear.

You can also view related content by tapping information on the screen.

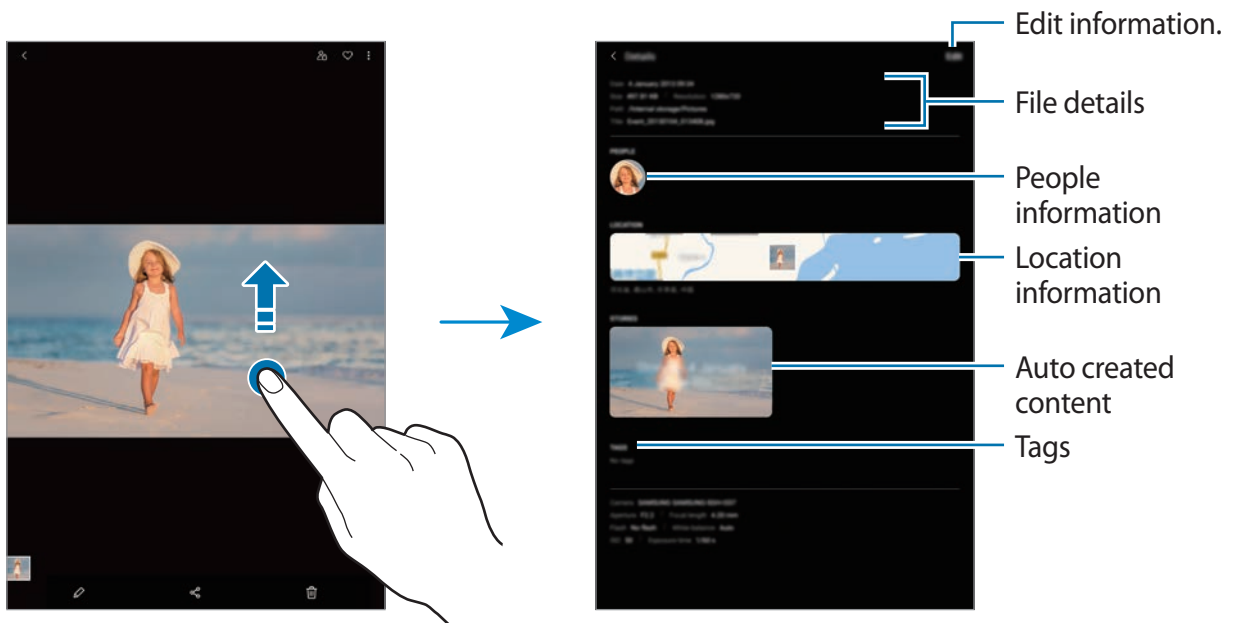

Viewing albums

You can view your images and videos sorted by folders or albums.

Launch the **Gallery** app, tap **Albums**, and then select an album.

Hiding albums

You can hide albums.



You cannot hide albums created by default, such as the **Camera** and **Screenshots** albums.

- 1 Launch the **Gallery** app and tap **Albums**.
- 2 Tap **⋮** → **Hide or unhide albums**.
- 3 Tap an album switch to hide.

Viewing stories

When you capture or save images and videos, the device will read their date and location tags, sort the images and videos, and then create stories. To create stories automatically, you must capture or save multiple images and videos.

Launch the **Gallery** app, tap **Stories**, and then select a story.

Creating stories

Create stories with various themes.

- 1 Launch the **Gallery** app and tap **Stories**.
- 2 Tap **⋮** → **Create story**.
- 3 Enter a title for the story and tap **Create**.
- 4 Tick images or videos to include in the story and tap **Done**.

To add images or videos to a story, select a story and tap  → **Add**.

To remove images or videos from a story, select a story, tap  → **Edit**, tick images or videos to remove, and then tap **Remove from story**.

Deleting stories

- 1 Launch the **Gallery** app and tap **Stories**.
- 2 Tap and hold a story to delete, and tap **Delete**.

Sharing albums

Create albums and share them with your family and friends saved in your contacts. They can view shared albums on devices signed in to their Samsung account, such as smartphones, TVs, or refrigerators.



- To use this feature, your phone number must be verified. (SM-T395)
- To use this feature, you must register and sign in to your Samsung account.
- You may incur additional charges when sharing files via the mobile network. (SM-T395)

Creating albums to share

- 1 Launch the **Gallery** app and tap **Shared**.
- 2 Tap **Create shared album**.
When using this feature for the first time, you must first agree to the terms and conditions of Samsung Social.
- 3 Enter a title for the album and tap **Create**.
- 4 Select a group to share with.
- 5 Tap **OK**.
The recipients will receive a notification.

Adding images or videos to an album

- 1 Launch the **Gallery** app and tap **Shared**.
- 2 Select an album to add images or videos.
- 3 Tap **+** and tick images or videos to add.
- 4 Tap **Done**.

Syncing images and videos with Samsung Cloud

When you sync your **Gallery** app with Samsung Cloud, photos and videos you take will also be saved in Samsung Cloud. You can view images and videos saved in Samsung Cloud in your **Gallery** app and from other devices.

Launch the **Gallery** app, tap  → **Settings**, and then tap the **Sync with Samsung Cloud** switch to activate it. The **Gallery** app and Samsung Cloud will be synced.

Deleting images or videos

Deleting an image or a video

Select an image or a video and tap  at the bottom of the screen.

Deleting multiple images and videos

- 1 On the Gallery screen, tap and hold an image or a video to delete.
- 2 Tick the images or videos to delete.
- 3 Tap **Delete**.

Multi window

Introduction

Multi window lets you run two apps at the same time in the split screen view. You can also run multiple apps at the same time in the pop-up view.



Some apps may not support this feature.



Split screen view

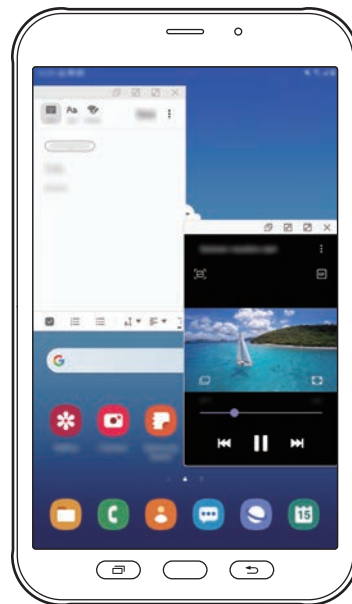

Pop-up view

Split screen view

- 1 Press the Recents key to open the list of recently used apps.
- 2 Swipe to the left or right, tap an app's icon, and then tap **Open in split screen view**.
The selected app will launch in the upper window.

3 On the lower window, swipe left or right to select another app to launch.

To launch apps not on the list of recently used apps, press the Home key or the Back key and select an app.

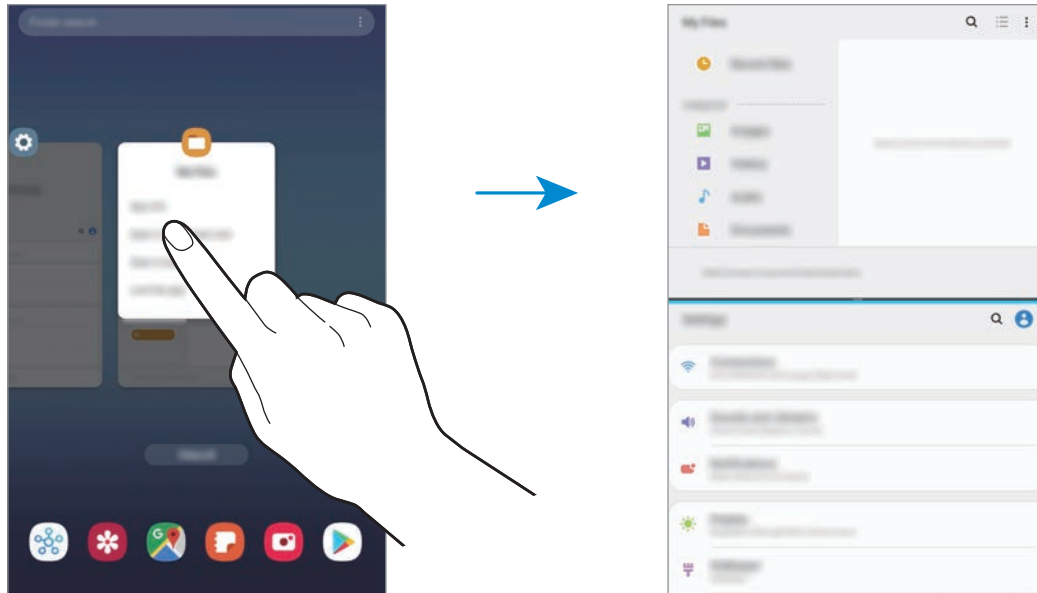

Adjusting the window size

Drag the bar between the app windows up or down to adjust the size of the windows.

When you drag the bar between the app windows to the top or bottom edge of the screen, the window will be maximised.

Pop-up view

- 1 Press the Recents key to open the list of recently used apps.
- 2 Swipe to the left or right, tap an app's icon, and then tap **Open in pop-up view**.
The app screen will appear in the pop-up view.

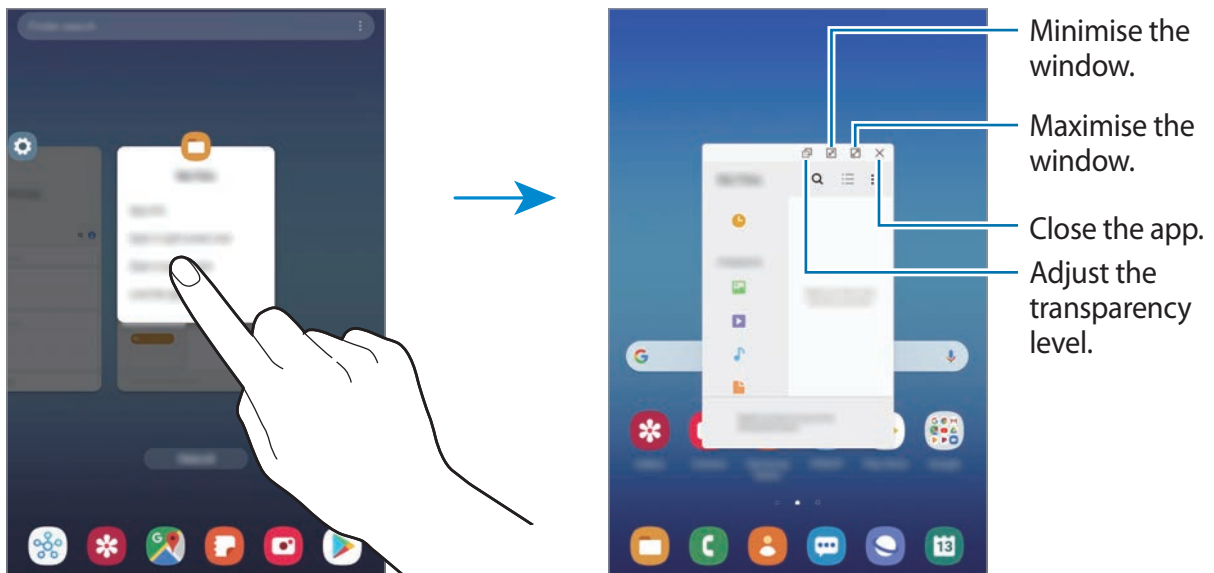

Moving pop-up windows

To move a pop-up window, tap the window's toolbar and drag it to a new location.

Samsung Members

Samsung Members offers support services to customers, such as device problem diagnosis, and lets users submit questions and error reports. You can also share information with others in the Galaxy users' community or view the latest Galaxy news and tips. **Samsung Members** can help you solve any problems you might encounter while using your device.



- This app's availability and supported features may vary depending on the region or service provider.
- To submit your feedback or post your comments, you must register and sign in to your Samsung account. Refer to [Samsung account](#) for more information.

Samsung Notes

Create notes by entering text from the keyboard or by handwriting or drawing on the screen. You can also insert images or voice recordings into your notes.

Creating notes

- 1 Launch the **Samsung Notes** app and tap .
- 2 Select an input method from the toolbar at the top of the screen and compose a note.

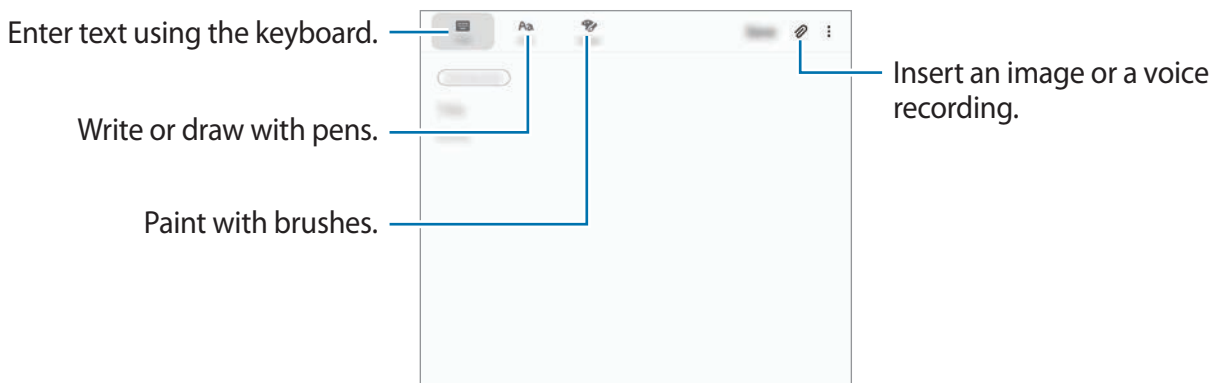

- 3 When you are finished composing the note, tap **Save**.

Composing notes with handwriting

On the note composer screen, tap **Pen** to write or draw with the S Pen.

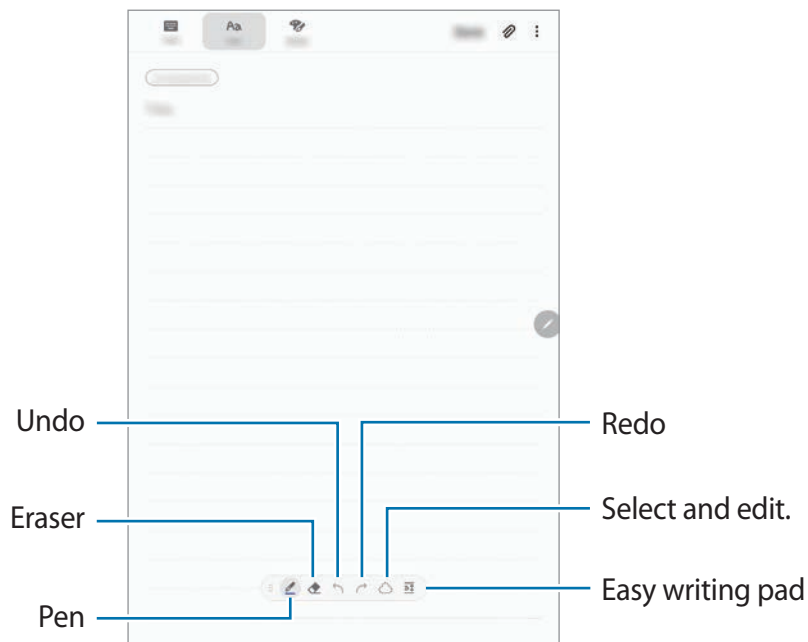

Changing the pen settings

When writing or drawing on the screen, tap  to change the pen type, line thickness, or pen colour.

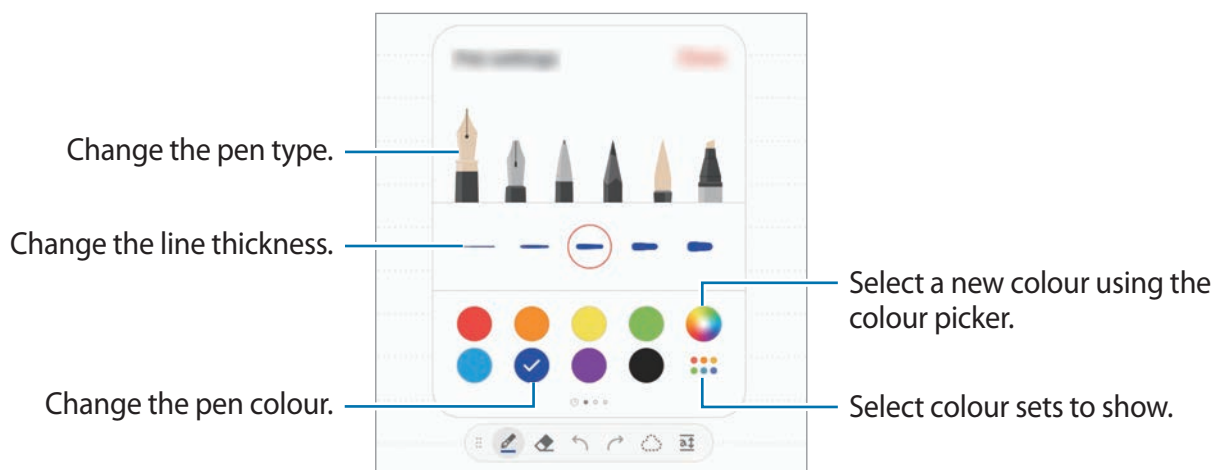

Using the eraser

When you want to erase handwriting from a note, tap  and select an area to erase. Alternatively, select an area while pressing and holding the S Pen button.

To change the eraser type, tap  once more.

- **Erase by line:** Erase the line you select.
- **Erase by area:** Erase only the area you select. You can adjust the size of the eraser by dragging the size adjustment bar.
- **Erase all:** Clear the note.



Even with a smaller eraser, you may still not be able to precisely erase the intended part.

Using the easy writing pad

Use the easy writing pad to enter your handwriting more easily.

When you write or draw on the easy writing pad, your handwriting will be automatically adjusted and entered between the lines of the input field.

On the note composer screen, tap . The input field will be magnified and appear as the easy writing pad.

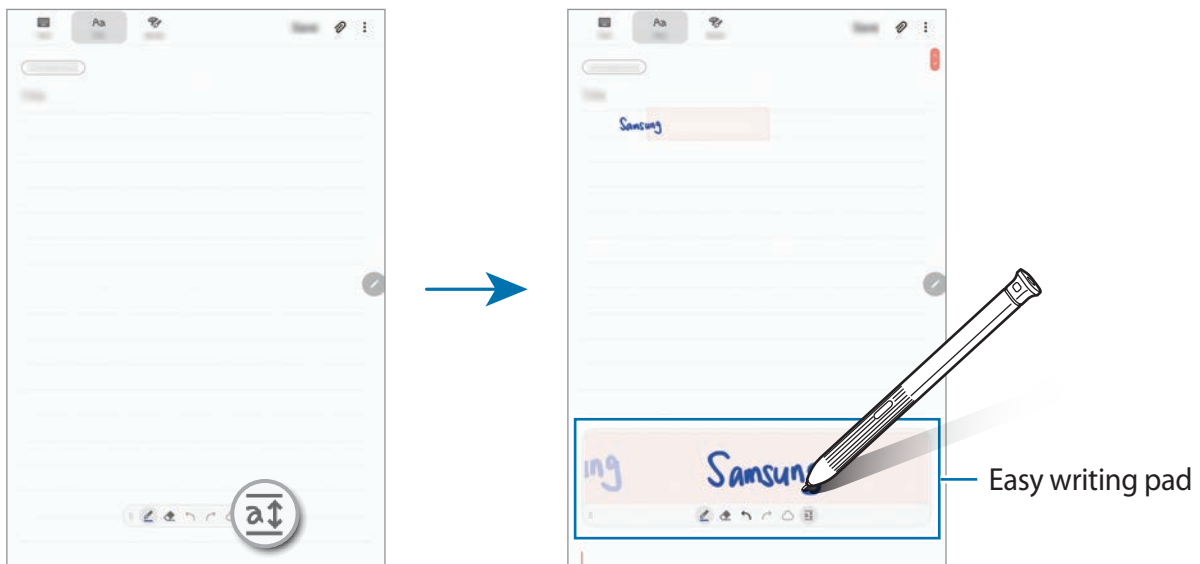

Editing handwritten notes

Edit handwritten notes using various editing options, such as cutting, moving, resizing, or transforming.

1 When there is handwriting on the note, tap .

To change the shape of the selection, tap  once more.

2 Tap or draw a line around the input to select.

To move the input to another location, select the input, and then drag it to a new location.

To change the size of the selection, tap the input and drag a corner of the frame that appears.

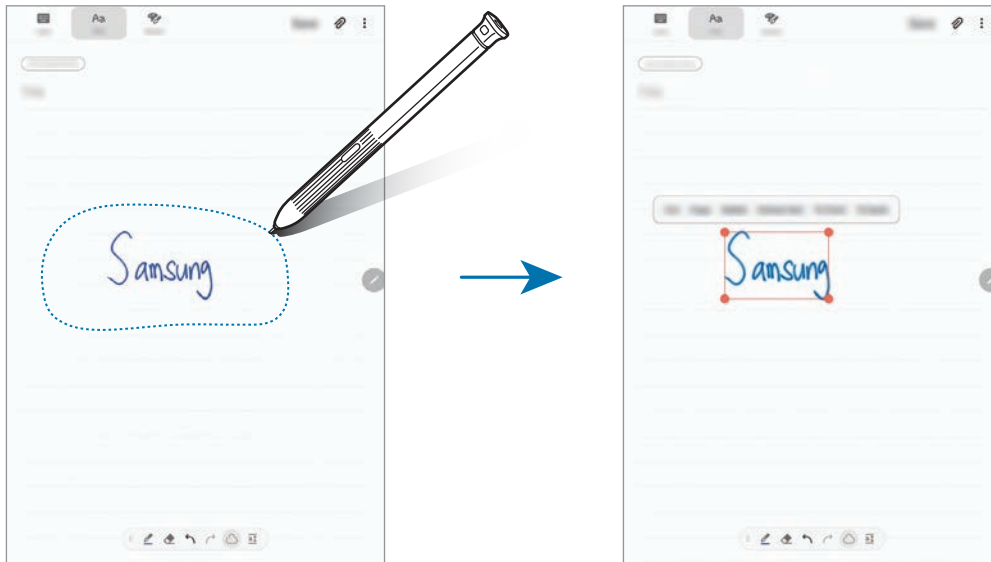

3 Edit the input using the available options.

- **Cut:** Cut out the input. To paste it to another location, tap and hold the location, and then tap **Paste**.
- **Copy:** Copy the input. To paste it to another location, tap and hold the location, and then tap **Paste**.
- **Delete:** Delete the input.
- **Extract text:** Extract text from the selected area. To paste or copy the text to a note, tap **Paste** or **Copy**.
- **To front:** Send the input to the front.
- **To back:** Send the input to the back.

Painting with brushes



On the note composer screen, tap **Brush** to paint with various brushes.

When you are finished, tap **Done** to insert your painting into the note.

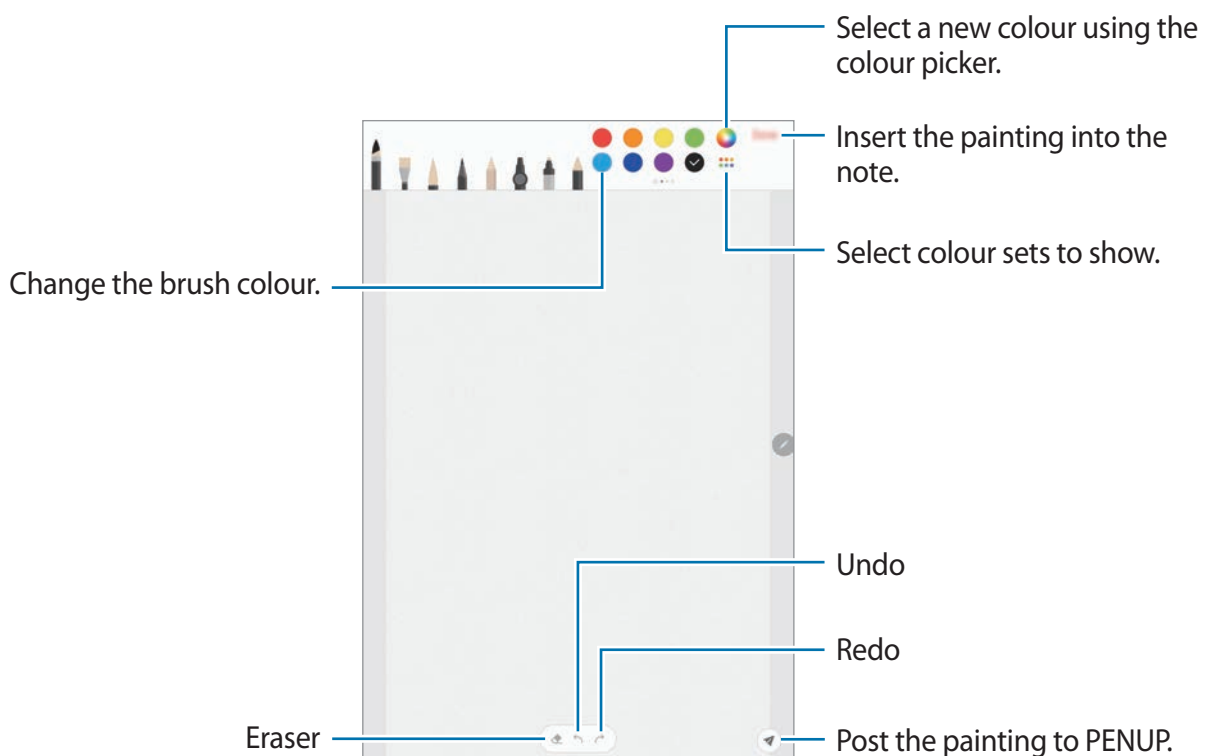

You can post your painting to PENUP to share it with others.



Inserting images into a note

On the note composer screen, tap  → **Image**. Tap **Camera** →  to take a photo, or tap **Gallery** or **Other** to select an image. The image will be inserted into your note.

Inserting voice recordings into a note

On the note composer screen, tap  → **Voice recordings** to make a voice recording. Tap  to stop recording. The voice recording will be inserted into your note.

Pinning a note to the Home screen

Pin a note to the Home screen to quickly view it or open and edit it.

- 1 Launch the **Samsung Notes** app.
- 2 Select a note and tap  → **Pin to home screen**.
The note will be added to the Home screen.

Saving a note as a reminder

You can save a note as a reminder to view the note later.

- 1 Launch the **Samsung Notes** app.
- 2 Select a note and tap  → **Send to Reminder**.
The note will be saved as a reminder.

Deleting notes

- 1 Launch the **Samsung Notes** app.
- 2 Tap and hold a note to delete.
To delete multiple notes, tick more notes to delete.
- 3 Tap **Delete**.

PENUP

Introduction

PENUP is a social network service for sharing artwork drawn with the S Pen. Post your artwork, view others' artwork, and get useful drawing tips.

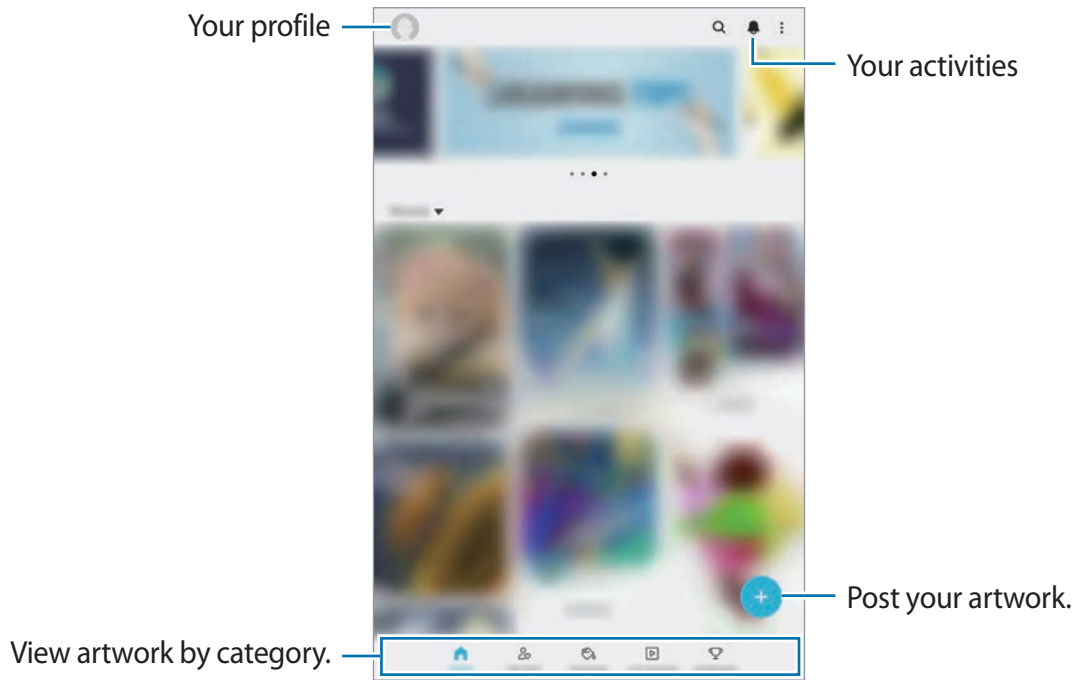

You can sign in to PENUP with your Samsung account or other SNS accounts.

Posting your artwork

Post your artwork created in **Samsung Notes** or other drawing apps to PENUP.

- 1 Launch the **PENUP** app and tap **+**.
- 2 To post artwork from **Gallery**, tap **From Gallery**, select your artwork to post, and then tap **Done**.

To post new artwork, tap **Drawing**, draw artwork, and then tap **Done** → **Save and post**.

To post your draft, tap **Drafts**, finish artwork, and then tap **Done** → **Save and post**.

- 3 Enter a title, description, and hashtag.

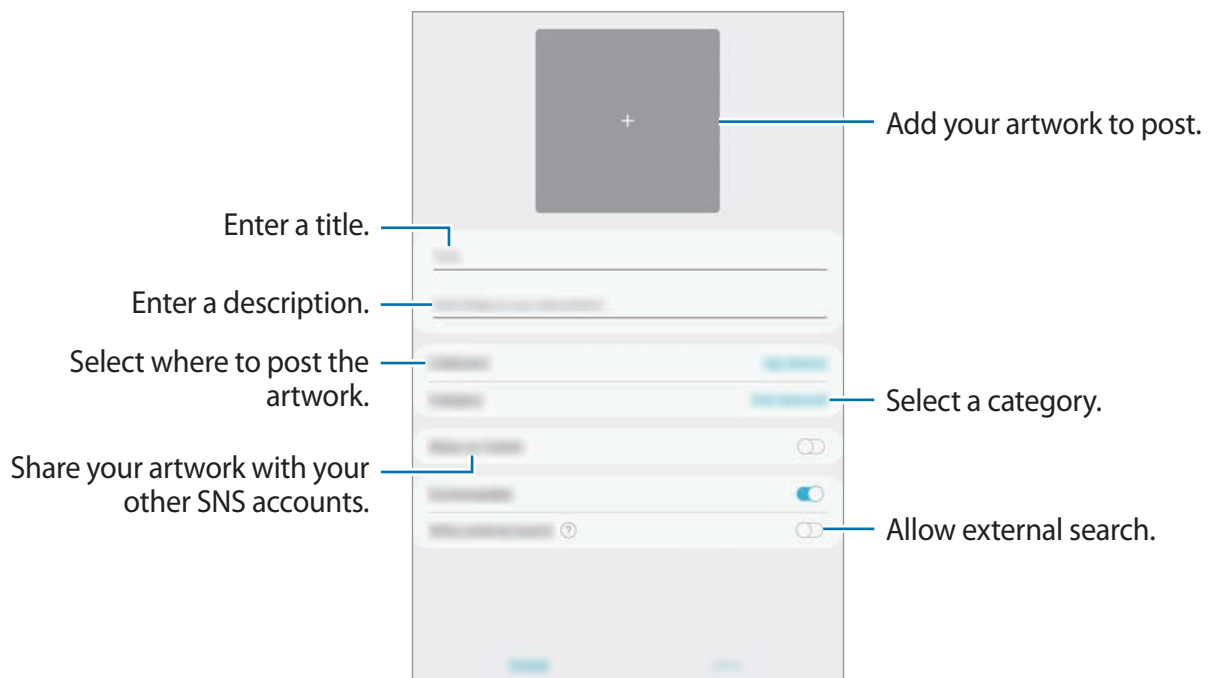

- 4 Tap **Post**.

Posting artwork from other apps

To post your artwork from **Gallery** or other drawing apps, select the artwork from an app and tap **🔗** → **PENUP**.

Viewing artwork

You can view other people's artwork, make comments, and even mark them as favourites. You can also download artwork or set one as your wallpaper.

Launch the **PENUP** app and select a post you want to view.

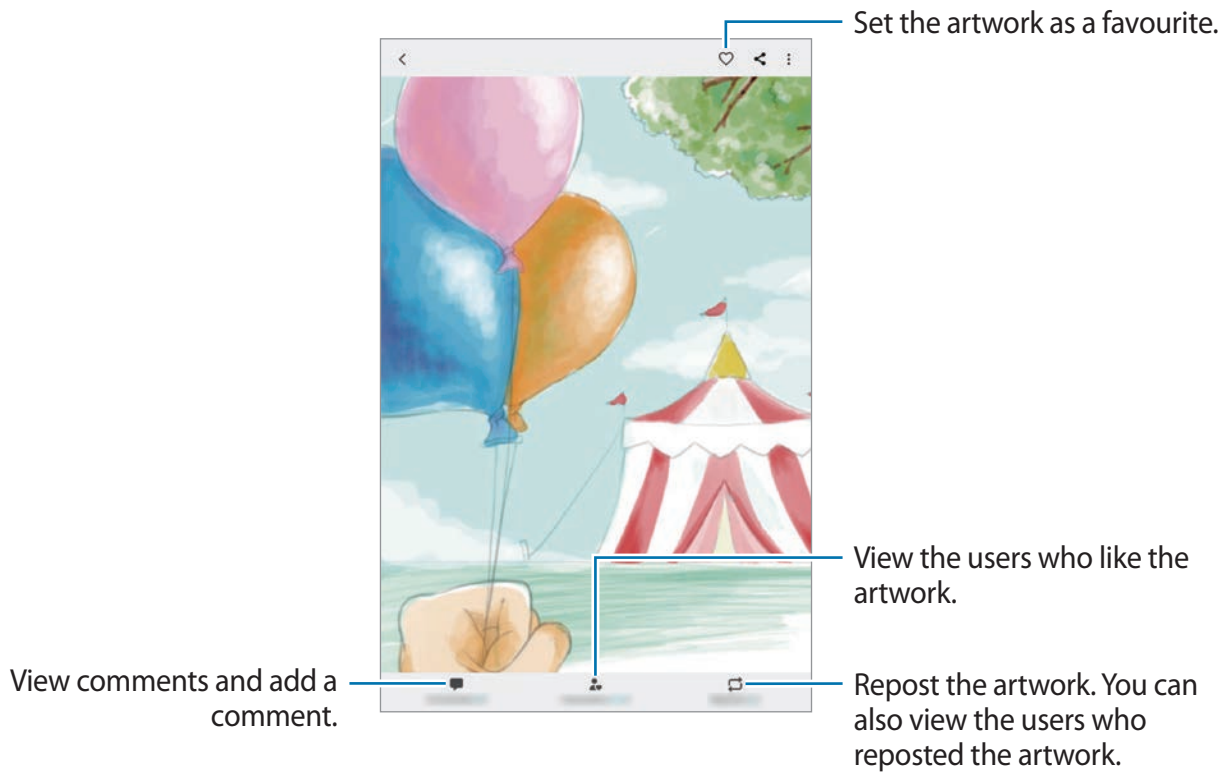

To download artwork, tap  → **Download**. Downloaded artwork will be saved in **Gallery**. You can only download artwork permitted by owners.

Colouring images

Using the various colours, create your own artwork.

- 1 Launch the **PENUP** app and tap **Colouring**.
- 2 Select an image.
- 3 Tap **Start colouring**.

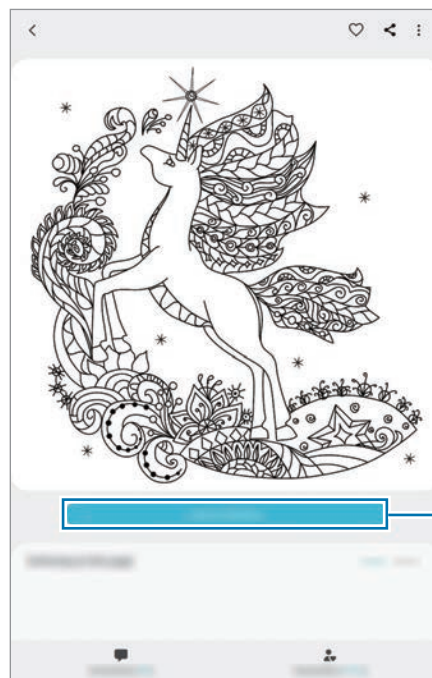

Start colouring.

- 4 When you are finished, tap **Done**.

Live drawing

Draw along as you watch the live drawing video that shows the process of completing an image. You can easily draw a nice image.

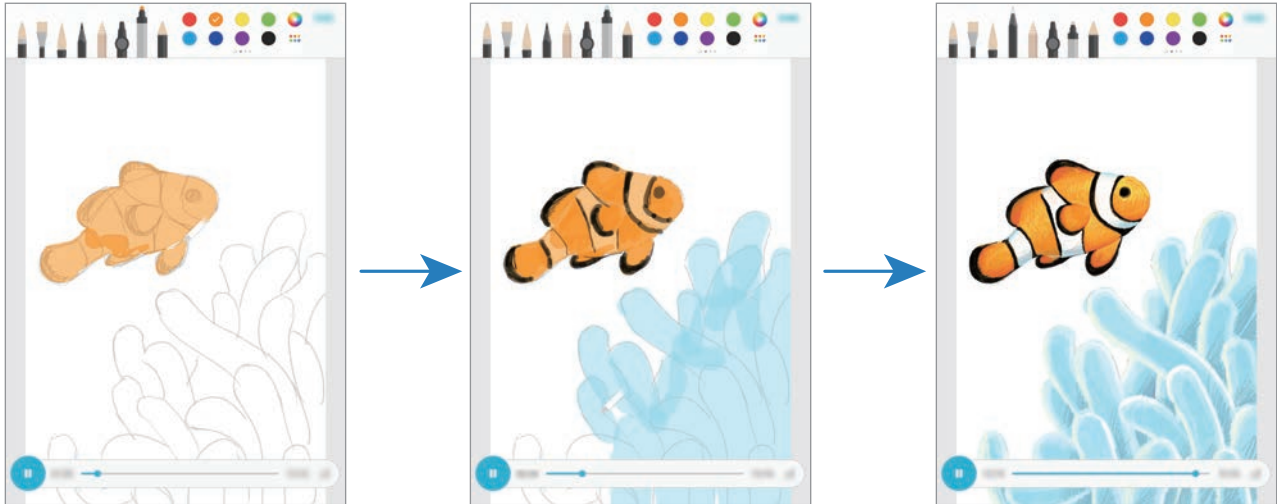



- 1 Launch the **PENUP** app and tap **Live drawing**.
- 2 Select an image.
- 3 Tap **Learn to draw**.
- 4 To draw on the image, tap **⏸** to pause the playback.
You can change the playback speed by tapping **x1**.
- 5 When you are finished, tap **👉**.
The original image will be hidden and you can see the image you drew.

Photo drawing

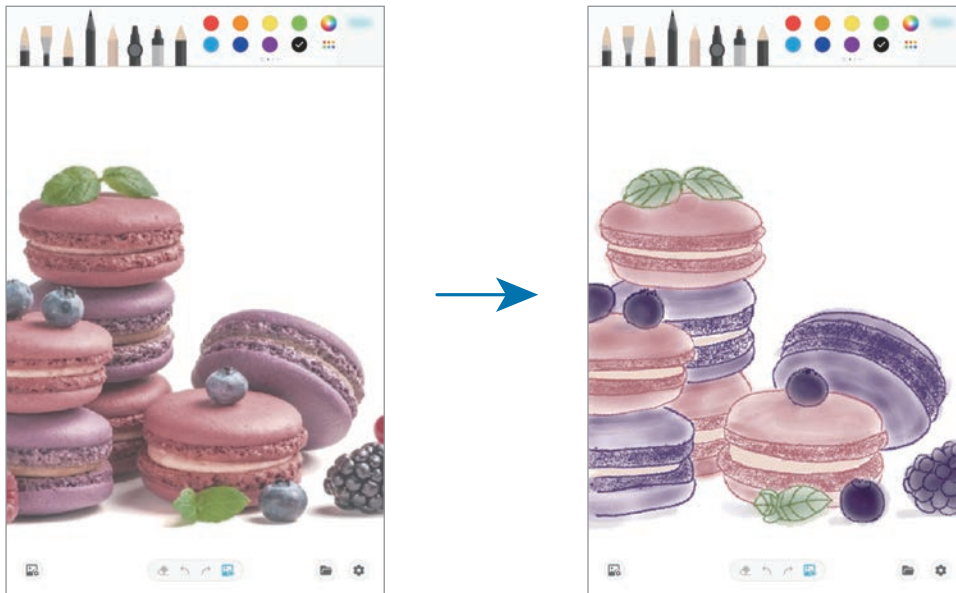
Draw images on your photos and keep them as your own works of art. Select a photo from **Gallery** or take a photo and draw on the photo. After completing your drawing, you can see the image you drew by hiding the photo.



- 1 Launch the **PENUP** app.
 - 2 Tap **+** → **Drawing** → .
 - 3 Tap **Take picture**, take a photo, and then tap **OK**.
Alternatively, tap **Select from Gallery** and select a photo.
 - 4 Select the area to draw, adjust the transparency level, and then tap **Save**.
The selected area will be added as a background.
 - 5 Draw on the photo.
 - 6 When you are finished, tap .
- The photo will be hidden and you can see the image you drew.

Calendar

Manage your schedule by entering upcoming events or reminders in your planner.

Creating events

1 Launch the **Calendar** app and tap **+** or double-tap a date.
If the date already has saved events or tasks in it, tap the date and tap **+**.

2 Enter event details.

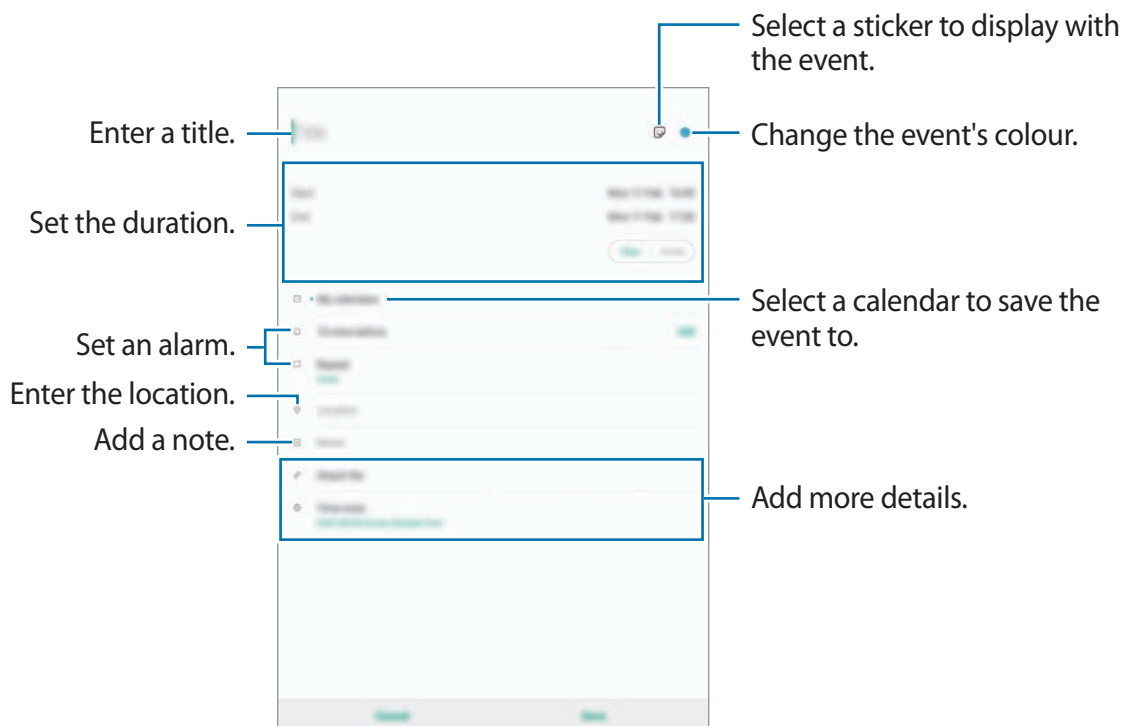



3 Tap **Save** to save the event.

Adding a reminder

Launch the **Calendar** app and tap  → **Reminder** to launch the **Reminder** app. Add a task on the **Reminder** app. Refer to [Reminder](#) for more information.

Syncing events with your accounts

- 1 Launch the **Settings** app, tap **Accounts and backup** → **Accounts** and select the account to sync with.
- 2 Tap **Sync account** and tap the **Calendar** switch to activate it.
For the Samsung account, tap  → **Sync settings** and tap the **Calendar** switch to activate it.

To add accounts to sync with, launch the **Calendar** app and tap  →  → **Add new account**. Then, select an account to sync with and sign in. When an account is added, it will appear on the list.

Samsung Flow

Introduction

Samsung Flow allows you to easily connect your tablet to your smartphone and use them conveniently, such as checking notifications or sharing contents.

Samsung Flow must be installed on both devices that you want to connect. If Samsung Flow is not installed, download it from **Galaxy Store** or **Play Store**.



- This feature is only available on some Samsung Android devices.
- To use this feature, you must activate Bluetooth feature on your tablet and your smartphone.

Connecting your tablet and smartphone

1 On your smartphone, launch Samsung Flow.

2 On your tablet, launch the **Samsung Flow** app.



If you are using this feature for the first time, tap **Start**.

3 Select your smartphone from the detected devices list.

4 Accept the connection request on both devices.

5 Confirm the passkey on both devices.

The devices will be connected.



If your smartphone supports fingerprint recognition feature, set up Samsung Pass on your smartphone to connect the devices more easily and securely using your fingerprint.

Sharing mobile data connection

Share your smartphone's mobile data connection with your tablet using a mobile hotspot when the Internet connection is not available on your tablet.

1 On your tablet, launch the **Samsung Flow** app.

2 Tap .

You can access the Internet on your tablet using your smartphone's mobile data connection.



- Your smartphone must support the mobile hotspot feature.
- You may incur additional charges on your smartphone when using this feature.

Checking notifications on your tablet

When you receive new notifications on your smartphone, check the notifications in pop-up window on your tablet.

Sharing contents

You can share your smartphone's contents with your tablet.

My Files

Access and manage various files stored in the device or in other locations, such as cloud storage services.

Launch the **My Files** app.

View files that are stored in each storage.

To check for unnecessary data and free up the device's storage, tap  → **Storage analysis**.

To search for files or folders, tap **Q**.

Clock

Introduction

Set alarms, check the current time in many cities around the world, time an event, or set a specific duration.

Alarm

Launch the **Clock** app and tap **Alarm**.

Setting alarms

Tap **+** in the alarms list, set an alarm time, select the days on which the alarm will repeat, set other various alarm options, and then tap **Save**.

To open the keypad to enter an alarm time, tap the time input field.

To activate or deactivate alarms, tap the switch next to the alarm in the alarms list.

Stopping alarms

Tap **Dismiss** to stop an alarm. If you have previously enabled the snooze option, tap **Snooze** to repeat the alarm after a specified length of time.

Deleting alarms

Tap and hold an alarm, tick alarms to delete, and then tap **Delete**.

World Clock

Launch the **Clock** app and tap **World Clock**.

Creating clocks

Tap **+**, enter a city name or select a city from the map, and then tap **Add**.

To use the time zone converter, tap **⋮** → **Time zone converter**.

Deleting clocks

Tap and hold a clock, tick clocks to delete, and then tap **Delete**.

Stopwatch

1 Launch the **Clock** app and tap **Stopwatch**.

2 Tap **Start** to time an event.

To record lap times while timing an event, tap **Lap**.

3 Tap **Stop** to stop timing.

To restart the timing, tap **Resume**.

To clear lap times, tap **Reset**.

Timer

- 1 Launch the **Clock** app and tap **Timer**.
To add a frequently used timer, tap **+**, set the duration and name, and then tap **Add**.
- 2 Set the duration, and then tap **Start**.
To open the keypad to enter the duration, tap the duration input field.
- 3 Tap **Dismiss** when the timer goes off.

Calculator

Perform simple or complex calculations.

Launch the **Calculator** app.

You can see the calculation history at the upper part of the screen.

To clear the history, tap **Clear history**.

To use the unit conversion tool, tap . You can convert various values, such as area, length, or temperature, into other units.

Bixby Home

On the Bixby Home screen, you can view recommended services and information that Bixby provides by analysing your usage patterns and your routine.



- To view more content, connect to a Wi-Fi or mobile network.
- To fully use this feature, you must sign in to your Samsung account.

Opening Bixby Home

1 On the Home screen, swipe to the right.

The Bixby Home screen will appear.

When launching this feature for the first time or after performing a data reset, follow the on-screen instructions to complete the setup.

2 Swipe upwards or downwards to view recommended content.



3 To close Bixby Home, swipe to the left on the screen or press the Back key.

Using recommended content on Bixby Home



When you open Bixby Home, you can view the content that is frequently updated as cards. Swipe upwards or downwards to view the cards.

For example, on the way to the office in the morning, you can view your day's schedule and play your favourite music on the Bixby Home screen.



The content and order of the cards update automatically at a specified interval. To manually update cards, swipe downwards on the screen.

Editing cards list

- To pin a card to the top of the Bixby Home screen, tap  → **Pin to top**. To unpin a card, tap  → **Unpin**.
- To stop displaying a card on the list, drag the card to the right and tap **Don't show again**.
- To hide a card from the list, drag the card to the right and tap **Hide for now**.

Selecting apps to show as cards

Add or delete apps to show as cards on the Bixby Home screen.

On the Bixby Home screen, tap  → **Cards**, select an app, and then tap the switches next to items to add or delete them.



If an app is not installed on the device, you must install it to use it. On the Bixby Home screen, tap  → **Cards** and then download an app.

Customising the Bixby Home settings

On the Bixby Home screen, tap  → **Settings**.

- **Customisation Service:** Set to use Bixby's interactive and customised services to enhance your experience.
- **Bixby Home content providers:** Read and agree to or withdraw your agreement from the terms and conditions and privacy policies of each content provider.
- **About Bixby Home:** View the Bixby Home version and legal information.

Reminder

Create reminders to schedule to-do items or to view content later. You will receive notifications at the preset time or location for each reminder.



- To receive more accurate notifications, connect to a Wi-Fi or mobile network.
- To fully use this feature, you must sign in to your Samsung account.
- To use location reminders, the GPS feature must be activated.

Starting Reminder

Starting Reminder from Bixby Home

1 On the Home screen, swipe to the right.
The Bixby Home screen will appear.

2 Tap **Get started** on the **Reminder** card.

The Reminder screen will appear and the **Reminder** app icon (🔔) will be added to the Apps screen.

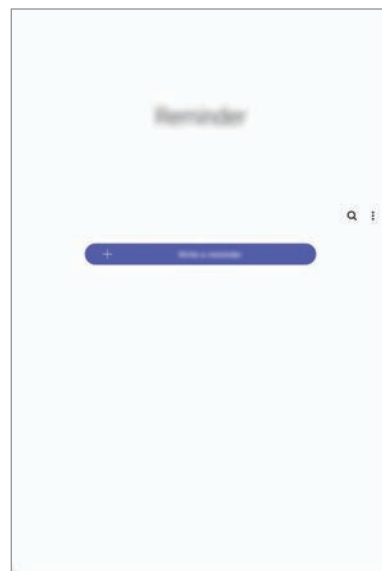
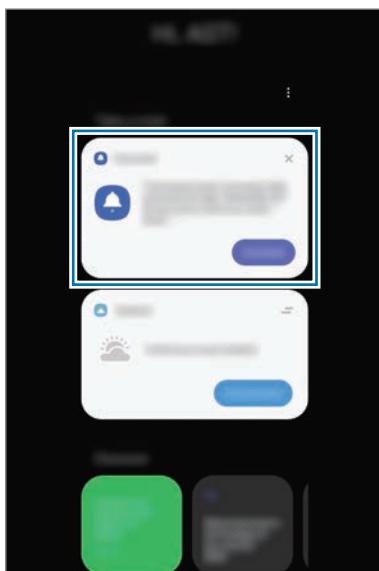

Starting Reminder from Calendar

Launch the **Calendar** app and tap  → **Reminder**. The Reminder screen will appear and the **Reminder** app icon () will be added to the Apps screen.

Creating reminders

Create reminders with various methods. Reminder will alert you if you create a reminder with a specified time or location setting. You can also save various content, such as a single memo or webpage address, and view it later.

For example, create a reminder to alert you to 'Water the flowers when I get home.'

- 1 Launch the **Reminder** app.
- 2 Tap **Write a reminder** or **+** and enter 'Water the flowers.'
- 3 Tap **Place** → **Set conditions** → **Pick a place** and set the location to home.
- 4 Tap **When I arrive at** → **Done**.

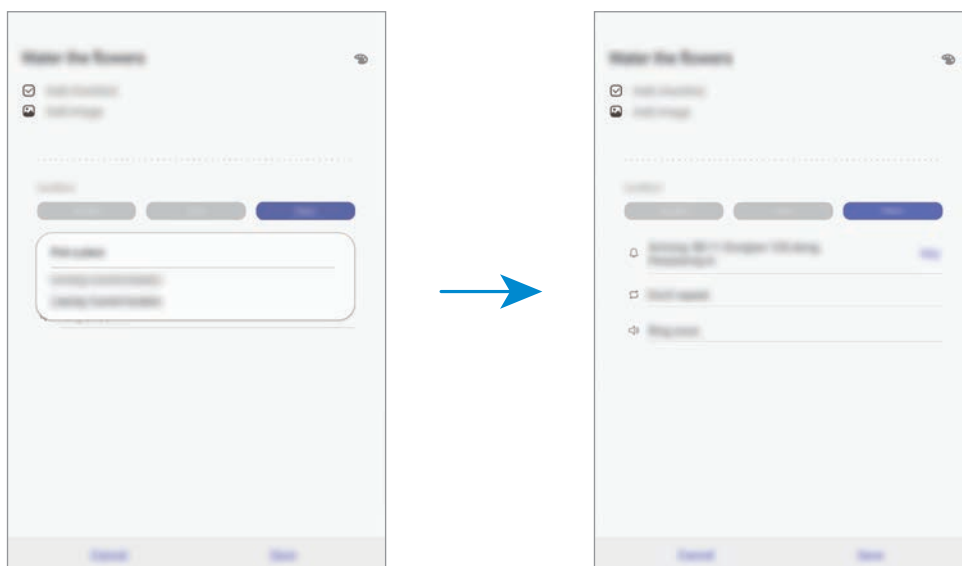

- 5 Tap **Save** to save the reminder.

When you arrive at home, the 'Water the flowers' notification will appear.

Checking reminder notifications

At the preset time or location, a notification pop-up window will appear. Tap **Complete** or **Snooze**.



Viewing the reminders list

Launch the **Reminder** app to view your reminders list. To view reminder details, select a reminder.

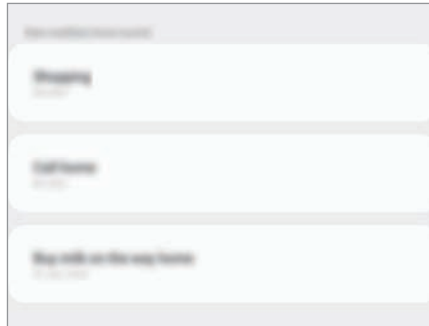

Editing reminder details

Add or edit reminder details, such as frequency, date and time, or location.

- 1 On the reminders list, select a reminder to edit and tap **Edit**.
- 2 Edit the conditions and tap **Save**.

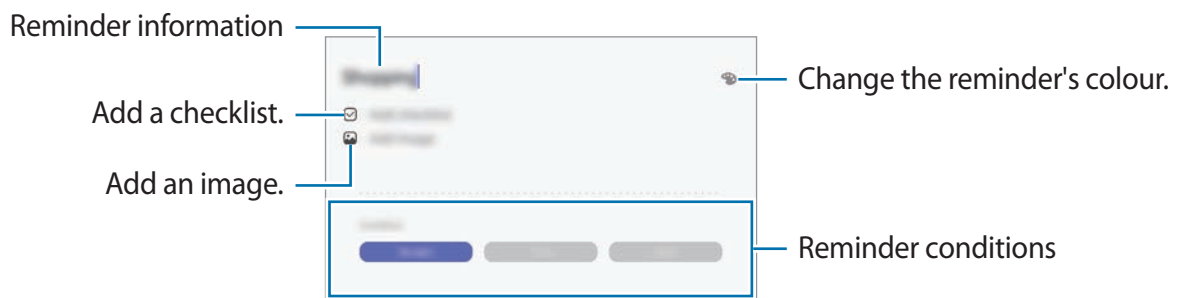

Completing reminders

Mark reminders that you do not need to be reminded of as complete.

On the reminders list, select a reminder and tap **Complete**. Alternatively, drag the reminder to the left.

Restoring reminders

Restore reminders that have been completed.

- 1 On the reminders list, tap **⋮** → **Completed** → **Edit**.
- 2 Tick items to restore and tap **Restore**.

Reminders will be added to the reminders list and you will be reminded at the preset times.

Deleting reminders

To delete a reminder, drag the reminder to the right. To delete multiple reminders, tap and hold a reminder, tick reminders to delete, and then tap **Delete**.

SmartThings

Introduction

Connect to nearby devices, such as Bluetooth headsets or other smartphones, easily and quickly. You can also control and manage TVs, home appliances, and Internet of Things (IoT) products with your tablet.

You can add and manage devices by location and room. For example, add 'home' as a location and manage devices by room, such as the living room and bedroom.

- **Connecting with nearby devices:** Connect with nearby devices, such as Bluetooth headsets or wearable devices, easily and quickly.
- **Registering and controlling home appliances, TVs, and IoT products:** Register smart refrigerators, washers, air conditioners, air purifiers, TVs, and Internet of Things (IoT) products on your tablet, and view their status or control them from your tablet's screen.
- **Receiving notification:** Receive notifications from connected devices on your tablet. For example, when the laundry is finished, you can receive a notification on your tablet.



- To use SmartThings, your tablet and other devices must be connected to a Wi-Fi or mobile network.
- To fully use SmartThings, you must sign in to your Samsung account.
- The devices you can connect may vary depending on the region or service provider.
- Available features may differ depending on the connected device.
- Connected devices' own errors or defects are not covered by the Samsung warranty. When errors or defects occur on the connected devices, contact the device's manufacturer.

Connecting to nearby devices

Connect to nearby devices, such as Bluetooth headsets, easily and quickly.



Connection methods may vary depending on the type of connected devices or the shared content.

- 1 Launch the **SmartThings** app.
- 2 Tap **+** → **Add device** → **Auto detect**.
- 3 Select a device from the list and connect to it by following the on-screen instructions.

Using home appliances, TVs, and IoT products

View the status of your smart appliances, TVs, and IoT products from your tablet's screen. You can group devices by location and add rules to control the devices easily and conveniently.

Connecting devices

- 1 Launch the **SmartThings** app.
- 2 Tap **+** → **Add device**.
- 3 Select a device type.
Or, tap **Auto detect** or **Q** to search for devices.
- 4 Follow the on-screen instructions to register devices.

Viewing and controlling connected devices

You can view and control the devices. For example, you can check the ingredients in your refrigerator or adjust the TV volume.

1 Launch the **SmartThings** app.

The list of connected devices will appear.



2 View the status of devices on the list.

To control the devices, select a device. When the device controller supplied with the selected device is downloaded, you can control the device.

Adding devices and scenes by locations

Add devices by locations, view the list of devices in a same location, and control them. You can also add a scene to a location to control multiple devices at the same time.

Adding locations

1 Launch the **SmartThings** app and tap  →  → **Add new location**.

2 Enter the location name.

- To set a location, tap **Geolocation** to select a location on the map and tap **Done**.
- To add rooms to the location, tap **Rooms**, tick rooms you want to add, and then tap **Done**.





3 Tap **Done**.

Your location will be added.

To add devices to the location, tap  → **Add device** and follow the on-screen instructions to register devices.

Adding scenes





Add a scene and register devices to it to control multiple devices at the same time.

- 1 Launch the **SmartThings** app.
- 2 Tap  →  and select a location.
- 3 Tap  → **Add scene**.
- 4 Enter the scene name.
- 5 Tap  under **Actions** to add actions to perform.
- 6 Tap **Save**.

Adding automations



You can also set an automation to operate devices automatically depending on the preset time, the status of devices, and more.

For example, add an automation to turn on the audio automatically every day at 7:00 AM.

- 1 Launch the **SmartThings** app.
- 2 Tap  →  and select a location.
- 3 Tap  → **Add automation**.
- 4 Tap  under **If**, set the activation conditions for the automation, and then tap **Next**.
- 5 Tap  under **Then** and set actions to perform.
- 6 Tap **Done**.

Receiving notifications

You can receive notifications from connected devices on your tablet. For example, when the laundry is finished, you can receive a notification on your tablet.

To set devices to receive notifications, launch the **SmartThings** app, tap  →  → **Notifications**, and then tap the switches next to the devices you want.

Sharing content

Share content by using various sharing options. The following actions are an example of sharing images.



You may incur additional charges when sharing files via the mobile network.
(SM-T395)

- 1 Launch the **Gallery** app and select an image.
- 2 Tap  and select a sharing method, such as email.

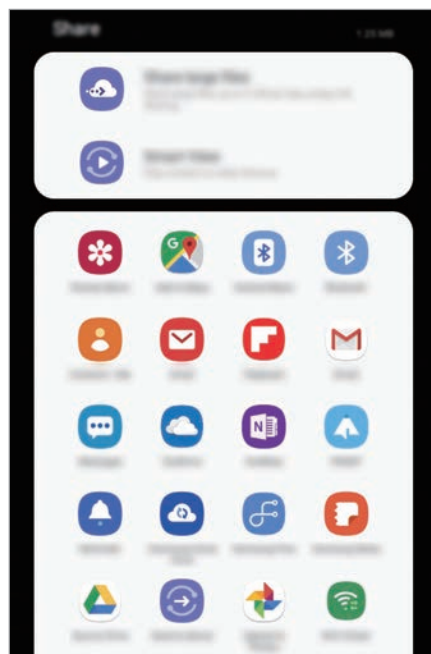

When you have a communication or sharing history, the people you contacted will appear on the sharing options panel. To directly share content with them via the corresponding app, select a person's icon. If the feature is not activated, launch the **Settings** app, tap **Advanced features**, and then tap the **Direct share** switch to activate it.

Using additional features

- **Share large files:** Share large files. Upload files to the Samsung storage server and share them with others via a Web link or a code. To use this feature, your phone number must be verified. (SM-T395)
- **Smart View:** Share content with nearby devices via Wi-Fi Direct or Bluetooth, or with SmartThings supported devices. You can also view your device's displayed content on a large screen by connecting your device to a screen mirroring-enabled TV or monitor.

When the image is sent to the recipients' devices, a notification will appear on their devices. Tap the notification to view or download the image.

Google apps

Google provides entertainment, social network, and business apps. You may require a Google account to access some apps.

To view more app information, access each app's help menu.



Some apps may not be available or may be labelled differently depending on the region or service provider.

Chrome

Search for information and browse webpages.

Gmail

Send or receive emails via the Google Mail service.

Maps

Find your location on the map, search the world map, and view location information for various places around you.

Play Music

Discover, listen to, and share music on your device. You can upload music collections stored on your device to the cloud and access them later.

Play Movies & TV

Purchase or rent videos, such as movies and TV programmes, from **Play Store**.

Drive

Store your content on the cloud, access it from anywhere, and share it with others.

YouTube

Watch or create videos and share them with others.

Photos

Search for, manage, and edit all your photos and videos from various sources in one place.

Google

Search quickly for items on the Internet or your device.

Duo (SM-T395)

Make a simple video call.

Hangouts (SM-T390)

Send messages, images, and emoticons to your friends and have video calls with them.

Settings

Introduction

Customise device settings. You can make your device more personalised by configuring various setting options.

Launch the **Settings** app.

To search for settings by entering keywords, tap **Q**.

Connections

Options

Change settings for various connections, such as the Wi-Fi feature and Bluetooth.

On the Settings screen, tap **Connections**.

- **Wi-Fi:** Activate the Wi-Fi feature to connect to a Wi-Fi network and access the Internet or other network devices. Refer to [Wi-Fi](#) for more information.
- **Bluetooth:** Use Bluetooth to exchange data or media files with other Bluetooth-enabled devices. Refer to [Bluetooth](#) for more information.
- **Tablet visibility:** Allow other devices to find your device to share content with you. When this feature is activated, your device will be visible to other devices when they search for available devices using their Transfer files to device option.
- **NFC and payment:** Set the device to allow you to read near field communication (NFC) tags that contain information about products. You can also use this feature to make payments and buy tickets for transportation or events after downloading the required apps. Refer to [NFC and payment](#) for more information.

- **Flight mode:** Set the device to disable all wireless functions on your device. You can use only non-network services.



Follow the regulations provided by the airline and the instructions of aircraft personnel. In cases where it is allowed to use the device, always use it in flight mode.

- **Mobile networks:** Configure your mobile network settings. (SM-T395)
- **Data usage**
 - ▶ **SM-T395:** Keep track of your data usage amount and customise the settings for the limitation. Set the device to automatically disable the mobile data connection when the amount of mobile data you have used reaches your specified limit.
You can also activate the data saver feature to prevent some apps running in the background from sending or receiving data. Refer to [Data saver \(SM-T395\)](#) for more information.
 - ▶ **SM-T390:** Keep track of your data usage amount.
- **Mobile Hotspot and Tethering:** Use the device as a mobile hotspot to share the device's mobile data connection with other devices when the network connection is not available. Connections can be made via Wi-Fi, USB, or Bluetooth. Refer to [Mobile Hotspot and Tethering \(SM-T395\)](#) for more information. (SM-T395)
- **More connection settings:** Customise settings to control other features. Refer to [More connection settings](#) for more information.

Wi-Fi

Activate the Wi-Fi feature to connect to a Wi-Fi network and access the Internet or other network devices.

Connecting to a Wi-Fi network

1 On the Settings screen, tap **Connections** → **Wi-Fi**, and then tap the switch to activate it.

2 Select a network from the Wi-Fi networks list.

Networks that require a password appear with a lock icon. Enter the password and tap **Connect**.



- Once the device connects to a Wi-Fi network, the device will reconnect to that network each time it is available without requiring a password. To prevent the device connecting to the network automatically, select it from the list of networks and tap **Forget**.
- If you cannot connect to a Wi-Fi network properly, restart your device's Wi-Fi feature or the wireless router.

Wi-Fi Direct

Wi-Fi Direct connects devices directly via a Wi-Fi network without requiring an access point.

1 On the Settings screen, tap **Connections** → **Wi-Fi**, and then tap the switch to activate it.

2 Tap **Wi-Fi Direct**.

The detected devices are listed.

If the device you want to connect to is not in the list, request that the device turns on its Wi-Fi Direct feature.

3 Select a device to connect to.

The devices will be connected when the other device accepts the Wi-Fi Direct connection request.

Sending and receiving data

You can share data, such as contacts or media files, with other devices. The following actions are an example of sending an image to another device.

- 1 Launch the **Gallery** app and select an image.
- 2 Tap  → **Wi-Fi Direct** and select a device to transfer the image to.
- 3 Accept the Wi-Fi Direct connection request on the other device.
If the devices are already connected, the image will be sent to the other device without the connection request procedure.

Ending the device connection

- 1 On the Settings screen, tap **Connections** → **Wi-Fi**.
- 2 Tap **Wi-Fi Direct**.
The device displays the connected devices in the list.
- 3 Tap the device name to disconnect the devices.

Bluetooth

Use Bluetooth to exchange data or media files with other Bluetooth-enabled devices.



- Samsung is not responsible for the loss, interception, or misuse of data sent or received via Bluetooth.
- Always ensure that you share and receive data with devices that are trusted and properly secured. If there are obstacles between the devices, the operating distance may be reduced.
- Some devices, especially those that are not tested or approved by the Bluetooth SIG, may be incompatible with your device.
- Do not use the Bluetooth feature for illegal purposes (for example, pirating copies of files or illegally tapping communications for commercial purposes). Samsung is not responsible for the repercussion of illegal use of the Bluetooth feature.

Pairing with other Bluetooth devices

- 1 On the Settings screen, tap **Connections** → **Bluetooth**, and then tap the switch to activate it.

The detected devices will be listed.

- 2 Select a device to pair with.

If the device you want to pair with is not on the list, set the device to enter Bluetooth pairing mode. Refer to the other device's user manuals.



Your device is visible to other devices while the Bluetooth settings screen is open.

- 3 Accept the Bluetooth connection request on your device to confirm.

The devices will be connected when the other device accepts the Bluetooth connection request.

Sending and receiving data

Many apps support data transfer via Bluetooth. You can share data, such as contacts or media files, with other Bluetooth devices. The following actions are an example of sending an image to another device.

- 1 Launch the **Gallery** app and select an image.
- 2 Tap  → **Bluetooth**, and then select a device to transfer the image to.
If your device has paired with the device before, tap the device name without confirming the auto-generated passkey.
If the device you want to pair with is not in the list, request that the device turns on its visibility option.
- 3 Accept the Bluetooth connection request on the other device.

Unpairing Bluetooth devices

- 1 On the Settings screen, tap **Connections** → **Bluetooth**.
The device displays the paired devices in the list.
- 2 Tap  next to the device name to unpair.
- 3 Tap **Unpair**.

NFC and payment

Your device allows you to read near field communication (NFC) tags that contain information about products. You can also use this feature to make payments and buy tickets for transportation or events after downloading the required apps.



The device contains a built-in NFC antenna. Handle the device carefully to avoid damaging the NFC antenna.

Reading information from NFC tags

Use the NFC feature to read product information from NFC tags.

- 1 On the Settings screen, tap **Connections** and tap the **NFC and payment** switch to activate it.
- 2 Place the NFC antenna area on the back of your device near an NFC tag.
The information from the tag appears.

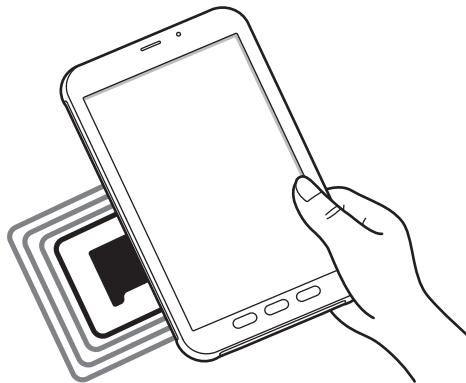

Ensure that the device's screen is turned on and unlocked. Otherwise, the device will not read NFC tags or receive data.

Making payments with the NFC feature

Before you can use the NFC feature to make payments, you must register for the mobile payment service. To register or get more information about the service, contact your service provider.

- 1 On the Settings screen, tap **Connections** and tap the **NFC and payment** switch to activate it.
- 2 Touch the NFC antenna area on the back of your device to the NFC card reader.

To set the default payment app, open the Settings screen and tap **Connections** → **NFC and payment** → **Tap and pay** → **PAYMENT**, and then select an app.



The payment services list may not include all available payment apps.

Sending data with the NFC feature

Transfer data, such as images or contacts, with other devices by touching your device's NFC antenna to the other device's NFC antenna.

- 1 On the Settings screen, tap **Connections** → **NFC and payment** and tap the switch to activate it.
- 2 Tap the **Android Beam** switch to activate it.
- 3 Select an item and touch the other device's NFC antenna to your device's NFC antenna.

4 When **Touch to beam.** appears on the screen, tap your device's screen to send the item.



If both devices try to send data simultaneously, the file transfer may fail.

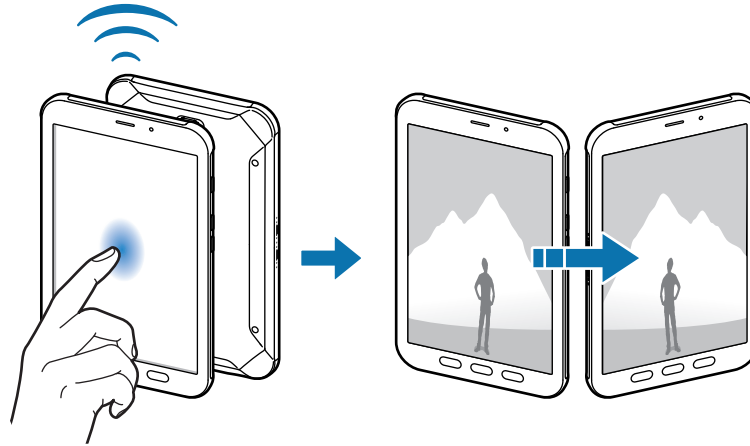

Data saver (SM-T395)

Reduce your data usage by preventing some apps running in the background from sending or receiving data.

On the Settings screen, tap **Connections** → **Data usage** → **Data saver** and tap the switch to activate it.

When the data saver feature is activated, the  icon will appear on the status bar.

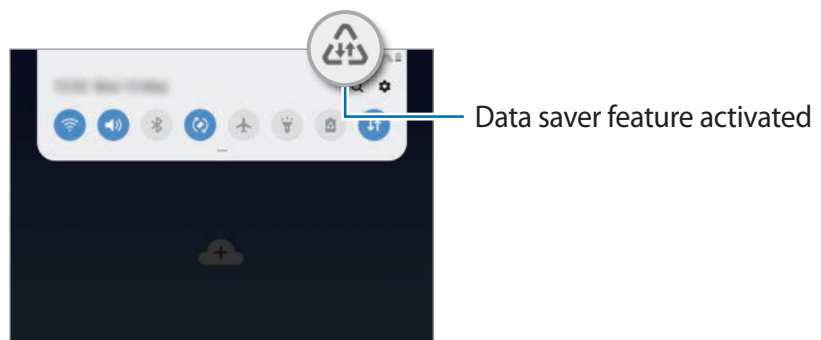

To select apps to use data without restriction, tap **Allow app while Data saver on** and select apps.

Mobile Hotspot and Tethering (SM-T395)

Use the device as a mobile hotspot to share the device's mobile data connection with other devices when the network connection is not available. Connections can be made via Wi-Fi, USB, or Bluetooth.

On the Settings screen, tap **Connections** → **Mobile Hotspot and Tethering**.



You may incur additional charges when using this feature.

- **Mobile Hotspot:** Use the mobile hotspot to share the device's mobile data connection with computers or other devices.
- **Bluetooth tethering:** Use Bluetooth tethering to share the device's mobile data connection with computers or other devices via Bluetooth.
- **USB tethering:** Use USB tethering to share the device's mobile data connection with a computer via USB. When connected to a computer, the device is used as a wireless modem for the computer.

Using the mobile hotspot

Use your device as a mobile hotspot to share your device's mobile data connection with other devices.



- 1 On the Settings screen, tap **Connections** → **Mobile Hotspot and Tethering** → **Mobile Hotspot**.
- 2 Tap the switch to activate it.

The  icon appears on the status bar. Other devices can find your device in the Wi-Fi networks list.

To set a password for the mobile hotspot, tap  → **Configure Mobile Hotspot** and select the level of security. Then, enter a password and tap **Save**.

3 On the other device's screen, search for and select your device from the Wi-Fi networks list.



- If the mobile hotspot is not found, on your device, tap  → **Configure Mobile Hotspot**, deselect **Hide my device**.
- If the other device cannot connect to the mobile hotspot, on your device, tap  → **Allowed devices** and tap the **Allowed devices only** switch to deactivate it.

4 On the connected device, use the device's mobile data connection to access the Internet.

More connection settings

Customise settings to control other connection features.

On the Settings screen, tap **Connections** → **More connection settings**.

- **Nearby device scanning:** Set the device to scan for nearby devices to connect to.
- **Printing:** Configure settings for printer plug-ins installed on the device. You can search for available printers or add one manually to print files. Refer to [Printing](#) for more information.
- **VPN:** Set up virtual networks (VPNs) on your device to connect to a school or company's private network.
- **Private DNS:** Use the reliable domain name system (DNS) for a school or company's internal private network instead of using the external hosting network. The DNS will be searched for and connected to automatically, or you can search for the DNS and connect to it manually.
- **Ethernet:** When you connect an Ethernet adaptor, you can use a wired network and configure network settings.

Printing

Configure settings for printer plug-ins installed on the device. You can connect the device to a printer via Wi-Fi or Wi-Fi Direct, and print images or documents.



Some printers may not be compatible with the device.

Adding printer plug-ins

Add printer plug-ins for printers you want to connect the device to.

- 1 On the Settings screen, tap **Connections** → **More connection settings** → **Printing** → **Download plugin**.
- 2 Search for a printer plug-in in **Play Store**.
- 3 Select a printer plug-in and install it.
- 4 Select the installed printer plug-in.
The device will automatically search for printers that are connected to the same Wi-Fi network as your device.
- 5 Select a printer to add.



To add printers manually, tap **⋮** → **Add printer**.

Printing content

While viewing content, such as images or documents, access the options list, tap **Print** → ▼ → **All printers...**, and then select a printer.



Printing methods may vary depending on the content type.

Sounds and vibration

Options

Change settings for various sounds on the device.

On the Settings screen, tap **Sounds and vibration**.

- **Sound mode:** Set the device to use sound mode, vibration mode, or silent mode.
- **Vibrate while ringing:** Set the device to vibrate and play a ringtone for incoming calls. (SM-T395)
- **Ringtone:** Change the call ringtone. (SM-T395)
- **Vibration pattern:** Select a vibration pattern. (SM-T395)
- **Notification sounds:** Change the notification sound.
- **Volume**
 - ▶ **SM-T395:** Adjust the volume level for call ringtones, music and videos, system sounds, and notifications.
 - ▶ **SM-T390:** Adjust the volume level for music and videos, system sounds, and notifications.
- **Use Volume keys for media:** Set the device to adjust the media volume level when you press the Volume key.
- **System sounds:** Set the device to sound for actions, such as turning the screen on or off or controlling the touchscreen.
- **Advanced sound settings:** Optimise the settings for when media is being played. Refer to [Separate app sound](#) for more information.

Separate app sound

Set the device to play media sound from a specific app on the connected Bluetooth speaker or headset separate from the sound of other apps.

For example, you can listen to the Navigation app through your device's speaker while listening to playback from the Music app through the vehicle's Bluetooth speaker.

- 1 On the Settings screen, tap **Sounds and vibration** → **Advanced sound settings** → **Separate app sound** and tap the switch to activate it.
- 2 Select an app to play media sounds separately and press the Back key.
- 3 Select a device for playing the selected app's media sound.

Notifications

Options

Change the notification settings.

On the Settings screen, tap **Notifications**.

- **App icon badges:** Change the settings for app icon badges. Refer to [App icon badges](#) for more information.
- **Do not disturb:** Set the device to mute notification sounds and media, except for allowed exceptions.
- **Status bar:** Set the device to display only three recent notifications and whether to show the remaining battery level in percentage on the status bar.
- **Recently sent:** View the apps that received recent notifications and change the notification settings. To customise notification settings for more apps, tap **See all** → ▼ → **All** and select an app from the app list.

App icon badges

Change the settings for app icon badges.

On the Settings screen, tap **Notifications** → **App icon badges**.

To display icon badges, tap the switch to activate it. To change the badge style, select an option under **Badge style**.

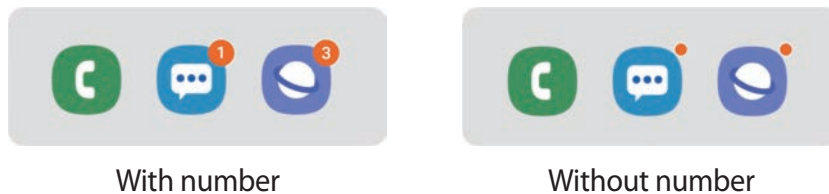

Display

Options

Change the display and the Home screen settings.

On the Settings screen, tap **Display**.

- **Brightness:** Adjust the brightness of the display.
- **Adaptive brightness:** Set the device to save power by adjusting the brightness of the display automatically.
- **Blue light filter:** Activate the blue light filter and change the filter settings. Refer to [Blue light filter](#) for more information.
- **Night mode:** Reduce eye strain by applying the dark theme when using the device at night or in a dark place.



- Turn on the GPS feature to set the device to activate night mode at night and turn it off in the morning based on your current location.
- The dark theme may not be applied in some apps.

- **Font size and style:** Change the font size and style.
- **Screen zoom:** Change the screen zoom setting.
- **Screen timeout:** Set the length of time the device waits before turning off the display's backlight.
- **Home screen:** Change the Home screen settings.
- **Accidental touch protection:** Set the device to prevent the screen from detecting touch input when it is in a dark place, such as a pocket or bag.
- **Touch sensitivity:** Increase the touch sensitivity of the screen for use with screen protectors.
- **Screensaver:** Set the device to launch a screensaver when the device is charging or connected to a dock. Refer to [Screensaver](#) for more information.

Blue light filter

Reduce eye strain by limiting the amount of blue light emitted by the screen.



While you are watching HDR videos from HDR-exclusive video services, the blue light filter may not be applied.

- 1 On the Settings screen, tap **Display** → **Blue light filter**, and then tap the **Turn on now** switch to activate it.
- 2 Drag the adjustment bar to adjust the filter's opacity.
- 3 To set the schedule to apply the blue light filter to the screen, tap the **Turn on as scheduled** switch to activate it and select an option.
 - **Sunset to sunrise:** Set the device to apply the blue light filter at night and turn it off in the morning based on your current location.
 - **Custom schedule:** Set a specific time to apply the blue light filter.

Screensaver

You can set to display images as a screensaver when the screen turns off automatically. The screensaver will be displayed when the device is charging or connected to a dock.

1 On the Settings screen, tap **Display** → **Screensaver** and tap the switch to activate it.

2 Select an option.

If you select **Photo Frame** or **Photos**, a slideshow with selected images will start. If you select **Photo Table**, selected images will appear as small cards and overlap.

3 Tap  to select albums for displaying images.

4 When you are finished, press the Back key.

To preview the selected option, tap **Preview**.



When you tap the screen while your screensaver is displayed, the screen will turn on.

Wallpaper

Change the wallpaper settings for the Home screen and the locked screen.

On the Settings screen, tap **Wallpaper**.

Lock screen

Options

Change the settings for the locked screen.

On the Settings screen, tap **Lock screen**.



The available options may vary depending on the screen lock method selected.

- **Screen lock type:** Change the screen lock method.
- **Smart Lock:** Set the device to unlock itself when trusted locations or devices are detected. Refer to [Smart Lock](#) for more information.
- **Secure lock settings:** Change screen lock settings for the selected lock method.
- **Clock style:** Change the type and colour of the clock on the locked screen.
- **Roaming clock:** Change the clock to show both the local and home time zones on the locked screen when roaming. (SM-T395)
- **FaceWidgets:** Change the settings of the items displayed on the locked screen.
- **Contact information:** Set the device to show contact information, such as your email address, on the locked screen.
- **Notifications:** Set how to show notifications on the locked screen.
- **App shortcuts:** Select apps to display shortcuts to them on the locked screen.
- **About Lock screen:** View the Locked screen version and legal information.

Smart Lock

You can set the device to unlock itself and remain unlocked when trusted locations or devices are detected.

For example, if you have set your home as a trusted location, when you get home your device will detect the location and automatically unlock itself.



- This feature will be available to use after you set a screen lock method.
- If you do not use your device for four hours or when you turn on the device, you must unlock the screen using the pattern, PIN, or password you set.

- 1 On the Settings screen, tap **Lock screen** → **Smart Lock**.
- 2 Unlock the screen using the preset screen lock method.
- 3 Select an option and follow the on-screen instructions to complete the setting.

Biometrics and security

Options

Change the settings for securing the device.

On the Settings screen, tap **Biometrics and security**.

- **Face recognition:** Set the device to unlock the screen by recognising your face. Refer to [Face recognition](#) for more information.
- **Fingerprints:** Register your fingerprints to unlock the screen. Refer to [Fingerprint recognition](#) for more information.
- **Biometrics preferences:** Change the settings for biometric data.
- **Google Play Protect:** Set the device to check for harmful apps and behaviour and warn about potential harm and remove them.
- **Find My Mobile:** Activate or deactivate the Find My Mobile feature. Access the Find My Mobile website (findmymobile.samsung.com) to track and control your lost or stolen device.

You can also allow the Google location service to provide more accurate information about the location of your device.

- **Security update:** View the version of your device's software and check for updates.
- **Samsung Pass:** Verify your identity easily and securely via your biometric data. Refer to [Samsung Pass](#) for more information.
- **Install unknown apps:** Set the device to allow the installation of apps from unknown sources.
- **Secure Folder:** Create a secure folder to protect your private content and apps from others. Refer to [Secure Folder](#) for more information.
- **Secure startup:** Protect your device by setting it to require a screen unlock code when turning on the device. You must enter the unlock code to start the device and receive messages and notifications.

- **Encrypt SD card:** Set the device to encrypt files on a memory card.
 -  If you reset your device to the factory defaults with this setting enabled, the device will not be able to read your encrypted files. Disable this setting before resetting the device.
- **Other security settings:** Configure additional security settings.
- **Location:** Change settings for location information permissions.
- **App permissions:** View the list of features and apps that have permission to use them. You can also edit the permission settings.
- **Permission usage monitor:** Set to receive notifications when the permissions you select are used by apps that you are not using. You can manage the settings of each app.
- **Send diagnostic data:** Set the device to automatically send the device's diagnostic and usage information to Samsung.
- **Receive marketing information:** Set whether to receive Samsung marketing information, such as special offers, membership benefits, and newsletters.

Face recognition

You can set the device to unlock the screen by recognising your face.



- If you use your face as a screen lock method, your face cannot be used to unlock the screen for the first time after turning on the device. To use the device, you must unlock the screen using the pattern, PIN, or password you set when registering the face. Be careful not to forget your pattern, PIN, or password.
- If you change the screen lock method to **Swipe** or **None**, which are not secure, all of your biometric data will be deleted. If you want to use your biometric data in apps or features, you must register your biometric data again.



Precautions for using face recognition

Before using the face recognition to unlock your device, keep the following precautions in mind.

- Your device could be unlocked by someone or something that looks like your image.
- Face recognition is less secure than Pattern, PIN, or Password.

For better face recognition

Consider the following when using face recognition:

- Consider the conditions when registering, such as wearing glasses, hats, masks, beards, or heavy makeup
- Ensure that you are in a well-lit area and that the camera lens is clean when registering
- Ensure your image is not blurry for better match results

Registering your face

For better face registration, register your face indoors and out of direct sunlight.

- 1 On the Settings screen, tap **Biometrics and security** → **Face recognition**.
- 2 Read the on-screen instructions and tap **Continue**.
- 3 Set a screen lock method.
- 4 Select whether you are wearing glasses or not and tap **Continue**.
- 5 Hold the device with the screen facing towards you and look at the screen.

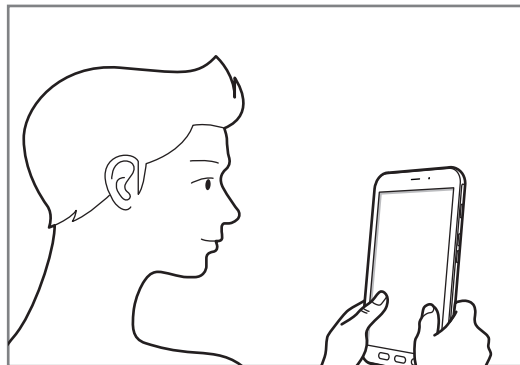

- 6 Position your face inside the frame on the screen.

The camera will scan your face.

When the useful face recognition screen appears, turn on a switch to activate a feature.



If unlocking the screen with your face is not working properly, tap **Remove face data** to remove your registered face and register your face again.

Deleting the registered face data

You can delete face data that you have registered.

- 1 On the Settings screen, tap **Biometrics and security** → **Face recognition**.
- 2 Unlock the screen using the preset screen lock method.
- 3 Tap **Remove face data** → **Remove**.

Once the registered face is deleted, all the related features will also be deactivated.

Unlocking the screen with your face

You can unlock the screen with your face instead of using a pattern, PIN, or password.

- 1 On the Settings screen, tap **Biometrics and security** → **Face recognition**.
- 2 Unlock the screen using the preset screen lock method.
- 3 Tap the **Face unlock** switch to activate it.



If you want to reduce the possibility of recognising faces in photos or videos, tap the **Faster recognition** switch to deactivate it. This may decrease the face recognition speed.

- 4 On the locked screen, look at the screen.

When your face is recognised, you can unlock the screen without using any additional screen lock method. If your face is not recognised, use the preset screen lock method.

Fingerprint recognition

In order for fingerprint recognition to function, your fingerprint information needs to be registered and stored in your device. After registering, you can set the device to use your fingerprint for the features below:

- Screen lock
- Secure Folder



- This feature may not be available depending on the region or service provider.
- Fingerprint recognition uses the unique characteristics of each fingerprint to enhance the security of your device. The likelihood of the fingerprint sensor confusing two different fingerprints is very low. However, in rare cases where separate fingerprints are very similar the sensor may recognise them as identical.
- If you use your fingerprint as a screen lock method, your fingerprint cannot be used to unlock the screen for the first time after turning on the device. To use the device, you must unlock the screen using the pattern, PIN, or password you set when registering the fingerprint. Be careful not to forget your pattern, PIN, or password.
- If your fingerprint is not recognised, unlock the device using the pattern, PIN, or password you set when registering the fingerprint, and then re-register your fingerprints. If your pattern, PIN, or password is forgotten, you will not be able to use the device if you do not reset it. Samsung is not responsible for any data loss or inconvenience caused by forgotten unlock codes.
- If you change the screen lock method to **Swipe** or **None**, which are not secure, all of your biometric data will be deleted. If you want to use your biometric data in apps or features, you must register your biometric data again.

For better fingerprint recognition

When you scan your fingerprints on the device, be aware of the following conditions that may affect the feature's performance:

- The device may not recognise fingerprints that are affected by wrinkles or scars.
- The device may not recognise fingerprints from small or thin fingers.
- To improve recognition performance, register fingerprints of the hand used most often to perform tasks on the device.
- The Home key has a fingerprint recognition sensor. Ensure that the fingerprint recognition sensor is not scratched or damaged by metal objects, such as coins, keys, and necklaces.
- Covering the fingerprint recognition sensor with protective films, stickers, or other accessories may decrease the fingerprint recognition rate. If the fingerprint recognition sensor is initially covered with a protective film, remove it before using the fingerprint recognition sensor.
- Ensure that the fingerprint recognition sensor and your fingers are clean and dry.
- If you bend your finger or use a fingertip, the device may not recognise your fingerprints. Make sure to cover the entire Home key with your finger.
- In dry environments, static electricity can build up in the device. Avoid using this feature in dry environments or before using the feature, discharge static electricity by touching a metal object.

Registering fingerprints

- 1 On the Settings screen, tap **Biometrics and security** → **Fingerprints**.
- 2 Read the on-screen instructions and tap **Continue**.
- 3 Set a screen lock method.
- 4 Register your fingerprint.
Place your finger on the Home key. After the device detects your finger, lift it up and place it on the Home key again.
Repeat this action until the fingerprint is registered.
- 5 When you are finished registering your fingerprints, tap **Done**.

Checking registered fingerprints

You can check whether your fingerprint is registered by placing your finger on the fingerprint recognition sensor.

- 1 On the Settings screen, tap **Biometrics and security** → **Fingerprints**.
- 2 Unlock the screen using the preset screen lock method.
- 3 Tap **Check added fingerprints**.
- 4 Place your finger on the fingerprint recognition sensor.
The recognition result will be displayed.

Deleting registered fingerprints

You can delete registered fingerprints.

- 1 On the Settings screen, tap **Biometrics and security** → **Fingerprints**.
- 2 Unlock the screen using the preset screen lock method.
- 3 Select a fingerprint to delete and tap **Remove**.

Unlocking the screen with your fingerprints

You can unlock the screen with your fingerprint instead of using a pattern, PIN, or password.

- 1 On the Settings screen, tap **Biometrics and security** → **Fingerprints**.
- 2 Unlock the screen using the preset screen lock method.
- 3 Tap the **Fingerprint unlock** switch to activate it.
- 4 On the locked screen, place your finger on the fingerprint recognition sensor and scan your fingerprint.

Samsung Pass

Samsung Pass allows you to sign in to your Samsung account, websites, or apps more easily and securely via your biometric data, rather than entering your login information. Also, Samsung Pass allows you to enter the personal information, such as your address or payment card information, more easily and quickly via your registered biometric data.

Register your biometric data to Samsung Pass and set to sign in to supported websites or apps using the data via Samsung Pass.



- To use this feature, your device must be connected to a Wi-Fi or mobile network.
- To use this feature, you must register and sign in to your Samsung account. For more information, refer to [Samsung account](#).
- The website sign-in feature is only available for websites that you access via the **Internet** app. Some websites may not support this feature.
- Registered biometric data and saved payment card information are only saved to your device and are not synced with other devices or servers.

Registering Samsung Pass

Before using Samsung Pass, register your biometric data to Samsung Pass.

- 1 On the Settings screen, tap **Biometrics and security** → **Samsung Pass**.
- 2 Read the on-screen instructions and tap **Sign-in**.
- 3 Enter your Samsung account ID and password and tap **Sign in**.
- 4 Agree to the terms and conditions of Samsung Pass.
- 5 Tap **Continue** and register your fingerprint.
Refer to [Fingerprint recognition](#) for more information.
- 6 Scan your fingerprint and tap **Next** to complete the Samsung Pass registration.
 - If the **Add Samsung Pass to Home screen** option is ticked, the Samsung Pass icon will be added on the Home screen.
 - If the **Use Samsung Pass instead of Samsung account password** option is ticked, you can use your registered biometric data to verify your identity instead of entering the Samsung account password.

Verifying the Samsung account password

You can use your registered biometric data to verify your identity instead of entering your Samsung account password when, for example, you purchase content from **Galaxy Store**.

- 1 On the Settings screen, tap **Biometrics and security** → **Samsung Pass**.
- 2 Unlock the screen using the preset screen lock method.
- 3 Tap **⋮** → **Settings** → **Samsung account**, and then tap the **Verify with Samsung Pass** switch to activate it.

Using Samsung Pass to sign in to websites

You can use Samsung Pass to easily sign in to websites that support ID and password autofill.

- 1 Open a website that you want to sign in to.
- 2 Enter your user name and password, and then tap the website's sign in button.
- 3 When a pop-up window asking whether you want to save the sign-in information appears, tick **Sign in using fingerprints via Samsung Pass** and tap **Remember**.

You can now use the biometric data you registered to Samsung Pass when signing in to the website.

Using Samsung Pass to sign in to apps

You can use Samsung Pass to easily sign in to apps that support ID and password autofill.

- 1 Open an app that you want to sign in to.
- 2 Enter your user name and password, and then tap the app's sign in button.
- 3 When a pop-up window asking whether you want to save the sign-in information appears, tap **Save**.

You can now use the biometric data you registered to Samsung Pass when signing in to the app.

Managing sign-in information

View the list of websites and apps you have set to use Samsung Pass and manage your sign-in information.

- 1 On the Settings screen, tap **Biometrics and security** → **Samsung Pass**.
- 2 Unlock the screen using the preset screen lock method.
- 3 Tap **Sign-in** and select a website or app from the list.
- 4 Tap **Edit** and modify your ID, password, and the website's or app's name.
To delete the website or app, tap **Delete**.

Using Samsung Pass with websites and apps

When using websites or apps that support Samsung Pass, you can easily sign in with Samsung Pass.

To see the list of websites and apps that support Samsung Pass, on the Settings screen, tap **Biometrics and security** → **Samsung Pass**, unlock the screen using your preset screen lock method, and then tap  → **Partners**. If there are no websites or apps that support Samsung Pass, **Partners** will not appear.



- Available websites and apps may vary depending on the region or service provider.
- Samsung is not responsible for any loss or inconvenience caused by signing in to websites or apps via Samsung Pass.

Entering your personal information automatically

You can use Samsung Pass to easily enter your address or payment card information on apps that support autofilling personal information.

- 1 On the Settings screen, tap **Biometrics and security** → **Samsung Pass**.
- 2 Unlock the screen using the preset screen lock method.
- 3 Tap **Autofill forms** and select **Add address** or **Add card**.
- 4 Enter the information and tap **Save**.

You can now use the biometric data you registered to Samsung Pass when entering the personal information automatically on supported apps.

Deleting your Samsung Pass data

You can delete your biometric data, sign-in information, and app data registered to Samsung Pass. Your agreement to the terms and conditions and your Samsung account will remain active.

- 1 On the Settings screen, tap **Biometrics and security** → **Samsung Pass**.
- 2 Unlock the screen using the preset screen lock method.
- 3 Tap **⋮** → **Settings** → **Delete data**.
- 4 Enter your Samsung account password and tap **OK**.

Your Samsung Pass data will be deleted.

Secure Folder

Secure Folder protects your private content and apps, such as photos and contacts, from being accessed by others. You can keep your private content and apps secure even when the device is unlocked.

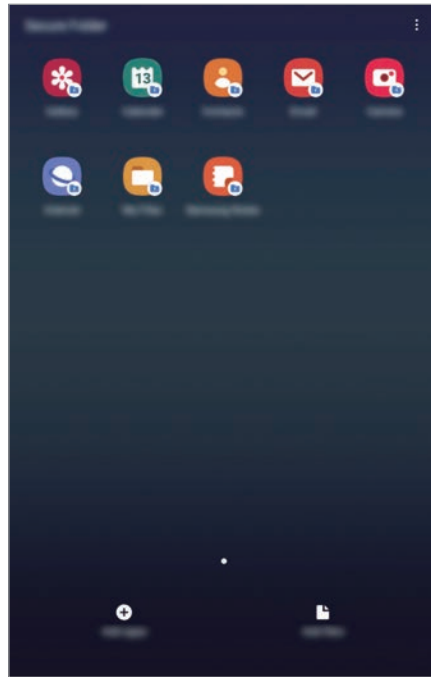

Secure Folder is a separate, secured storage area. The data in Secure Folder cannot be transferred to other devices via unapproved sharing methods, such as USB or Wi-Fi Direct. Attempting to customise the operating system or modifying software will cause Secure Folder to be automatically locked and inaccessible. Before saving data in Secure Folder, make sure to back up a copy of the data in another secure location.

Setting up Secure Folder

- 1 Launch the **Settings** app and tap **Biometrics and security** → **Secure Folder**.
- 2 Read and agree to the terms and conditions and tap **Agree**.
- 3 Enter your Samsung account ID and password and tap **Sign in**.
- 4 Select a lock method to use for Secure Folder and follow the on-screen instructions to complete the setup.

To change the name or icon colour of Secure Folder, tap  → **Customise icon**.



- When you launch the **Secure Folder** app, you must unlock the app using your preset lock method.
- If you forget your Secure Folder unlock code, you can reset it using your Samsung account. Tap the button at the bottom of the locked screen, and enter your Samsung account password.

Setting auto lock for Secure Folder

Set the device to automatically lock Secure Folder when it is not being used.

- 1 Launch the **Secure Folder** app and tap  → **Settings** → **Auto lock Secure Folder**.
- 2 Select a lock option.



To manually lock your Secure Folder, tap  → **Lock**.

Moving content to Secure Folder

Move content, such as photos and contacts, to Secure Folder. The following actions are an example of moving an image from the default storage to Secure Folder.

- 1 Launch the **Secure Folder** app and tap **Add files**.
- 2 Tap **Images**, tick images to move, and then tap **Done**.
- 3 Tap **Move**.
The selected items will be deleted from the original folder and moved to Secure Folder.
To copy items, tap **Copy**.



The method for moving content may vary depending on the content type.

Moving content from Secure Folder

Move content from Secure Folder to the corresponding app in the default storage. The following actions are an example of moving an image from Secure Folder to the default storage.

- 1 Launch the **Secure Folder** app and tap **Gallery**.
- 2 Select an image and tap **⋮** → **Move out of Secure Folder**.
The selected items will be moved to **Gallery** in the default storage.

Adding apps

Add an app to use in Secure Folder.

- 1 Launch the **Secure Folder** app and tap **Add apps**.
- 2 Tick one or more apps installed on the device and tap **Add**.
To install apps from **Play Store** or **Galaxy Store**, tap **Download from Play Store** or **Download from Galaxy Store**.

Removing apps from Secure Folder

Tap and hold an app to delete, and tap **Uninstall**.

Adding accounts

Add your Samsung and Google accounts, or other accounts, to sync with the apps in Secure Folder.

- 1 Launch the **Secure Folder** app and tap **⋮** → **Settings** → **Accounts** → **Add account**.
- 2 Select an account service.
- 3 Follow the on-screen instructions to complete the account setup.

Hiding Secure Folder

You can hide the Secure Folder shortcut from the Apps screen.

Launch the **Secure Folder** app, tap **⋮** → **Settings**, and then tap the **Show Secure Folder** switch to deactivate it.

Alternatively, drag the status bar downwards to open the notification panel. Then, swipe downwards on the notification panel and tap **Secure Folder** to deactivate the feature.



Backing up and restoring Secure Folder

Back up content and apps in Secure Folder to Samsung Cloud using your Samsung account and restore them later.

Backing up data

- 1 Launch the **Secure Folder** app and tap  → **Settings** → **Backup and restore**.
- 2 Tap **Add account** and sign in to your Samsung account.
- 3 Tap **Back up Secure Folder data**.
- 4 Tick items you want to back up and tap **Back up**.
Data will be backed up to Samsung Cloud.

Restoring data

- 1 Launch the **Secure Folder** app and tap  → **Settings** → **Backup and restore**.
- 2 Tap **Restore**.
- 3 Tap  to select a device to restore the data.
- 4 Select the data types you want to restore and tap **Restore**.
Backed up data will be restored to your device.

Uninstalling Secure Folder

You can uninstall Secure Folder, including the content and apps in it.

Launch the **Secure Folder** app and tap  → **Settings** → **More settings** → **Uninstall**.

To back up content before uninstalling Secure Folder, tick **Move media files out of Secure Folder** and tap **Uninstall**. To access data backed from Secure Folder, launch the **My Files** app and tap **Internal storage** → **Secure Folder**.



Notes saved in **Samsung Notes** will not be backed up.

Accounts and backup

Options

Sync, back up, or restore your device's data using Samsung Cloud. You can also register and manage accounts, such as your Samsung account or Google account, or transfer data to or from other devices via Smart Switch.

On the Settings screen, tap **Accounts and backup**.

- **Accounts:** Add your Samsung and Google accounts, or other accounts, to sync with.
- **Users:** Set up additional user accounts for other users to use the device with personalised settings, such as email accounts, wallpaper preferences, and more. Refer to [Users](#) for more information.
- **Backup and restore:** Keep your personal information, app data, and settings safe on your device. You can back up your sensitive information and access it later. You must sign in to your Google or Samsung account to back up or restore data.
- **Samsung Cloud:** Manage the content that you want to store securely in Samsung Cloud. Check the usage status of your Samsung Cloud storage, and sync, back up, and restore your data. Refer to [Samsung Cloud](#) for more information.
- **Smart Switch:** Launch Smart Switch and transfer data from your previous device. Refer to [Transferring data from your previous device \(Smart Switch\)](#) for more information.



Regularly back up your data to a safe location, such as Samsung Cloud or a computer, so that you can restore it if the data is corrupted or lost due to an unintended factory data reset.

Users

Set up additional user accounts for other users to use the device with personalised settings, such as email accounts, wallpaper preferences, and more. Following types of user accounts are available:

- **Administrator:** The administrator account is created only when setting up the device for the first time, and cannot be created more than one. This account has full control of the device including user account management. You can add or delete user accounts only when using this account.
- **Guest:** This account allows guests to access the device. Information and data used during a guest session is temporarily stored. Each time you use this account, you are asked whether to continue the previous guest session or reset it.
- **User:** This account allows users to access their own apps and content, and customise the device settings that affect all accounts.
- **User (restricted profile):** A restricted account can only access the apps and content allowed by the owner account, and cannot use the services that require logging in. (SM-T390)

Adding users

1 On the Settings screen, tap **Accounts and backup** → **Users**.

2 ▶ **SM-T395:** Tap **Add user or profile** → **OK** → **Set up now**.

▶ **SM-T390:** Tap **Add user or profile** → **User** → **OK** → **Set up now**.

The device will switch to a new user account and the default locked screen will appear on the screen.

3 Unlock the device and follow the on-screen instructions to complete the account setup.

Adding restricted profiles (SM-T390)

- 1 On the Settings screen, tap **Accounts and backup** → **Users**.
- 2 Tap **Add user or profile** → **User (restricted profile)**.
If you are not using a secure screen lock method with the administrator account, follow the on-screen instructions to set one up.
- 3 Select the apps and content that restricted users are allowed to access.

Switching users

Tap the user account icon at the top of the locked screen and select an account to switch to.



Locked screen

Managing users



► **SM-T395:** When using the administrator account, you can delete accounts or change account settings.

To delete a user account, tap  next to the account and then tap **Delete user**.

To change an account's settings, tap  next to an account.

► **SM-T390:** When using the administrator account, you can delete accounts or change the settings for restricted accounts.

To delete a user account, tap  next to the account and then tap **Delete**.

To change the settings for a restricted account, tap  next to an account. You can delete the account by tapping .

Samsung Cloud

Back up data from your previous device to Samsung Cloud and restore the data to your new device. You can also sync data saved in your device with Samsung Cloud and view data saved on the Samsung Cloud. You must register and sign in to your Samsung account to use Samsung Cloud. Refer to [Samsung account](#) for more information.

Backing up data from your previous device

1 On your previous device, sign in to your Samsung account.

2 Launch the **Settings** app, select the backup option, and back up your data.



- If your device supports Samsung Cloud, launch the **Settings** app, tap **Accounts and backup** → **Samsung Cloud** → **Back up this tablet**, tick items you want to back up, and then tap **Back up** to back up your data.
- The data backup method may vary depending on your model.
- Some data will not be backed up. To check which data will be backed up, launch the **Settings** app, tap **Accounts and backup** → **Samsung Cloud** → **Back up this tablet**.
- To view the backup data for each device in your Samsung Cloud, launch the **Settings** app, tap **Accounts and backup** → **Samsung Cloud** → **Restore data** → ▼, and then select a device you want.

Restoring data from your previous device

- 1 On your new device, launch the **Settings** app and tap **Accounts and backup** → **Samsung Cloud**.
- 2 Tap **Restore data** → ▼ and select a previous device.
- 3 Tick the data types you want to restore and tap **Restore**.

Syncing data from your device

You can sync data saved in your device, such as images, videos, and events, with Samsung Cloud and access it from other devices.

- 1 On your new device, launch the **Settings** app and tap **Accounts and backup** → **Samsung Cloud**.
- 2 Tap ☰ → **Settings** → **Sync and auto backup settings** → **Sync**.
- 3 Tap the switches next to the items you want to sync with.



You can check the saved data or change the settings by tapping the **Gallery**, **Other synced data**, or **Samsung Cloud Drive**.

Google

Configure settings for some features provided by Google.

On the Settings screen, tap **Google**.

Advanced features

Activate advanced features and change the settings that control them.

On the Settings screen, tap **Advanced features**.



Excessive shaking or an impact to the device may cause an unintended input for some features using sensors.

- **S Pen:** Change the settings for using the S Pen. Refer to [S Pen features](#) for more information about **Air command**, **Air view**, and **Screen off memo**.
- **Accessories:** Change the accessory settings. (SM-T390)
- **Daily Board:** Set the device to show a slideshow with selected images.
- **Smart pop-up view:** Select apps to view their notifications via pop-up windows. When using this feature, you can quickly view the contents via pop-up windows by tapping the icon on the screen.



This feature is only available in apps that support the Multi window feature.

- **Smart capture:** Set the device to capture the current screen and scrollable area, and crop and share the screenshot immediately.
- **Direct share:** Set the device to display the people you contacted on the sharing options panel to allow you to share content directly.
- **Reduce animations:** Set the device to reduce certain screen effects if you are sensitive to animations or screen movement.
- **Motions and gestures:** Activate the motion feature and configure settings.

Device care

The device care feature provides an overview of the status of your device's battery, storage, memory, and system security. You can also automatically optimise the device with a tap of your finger.

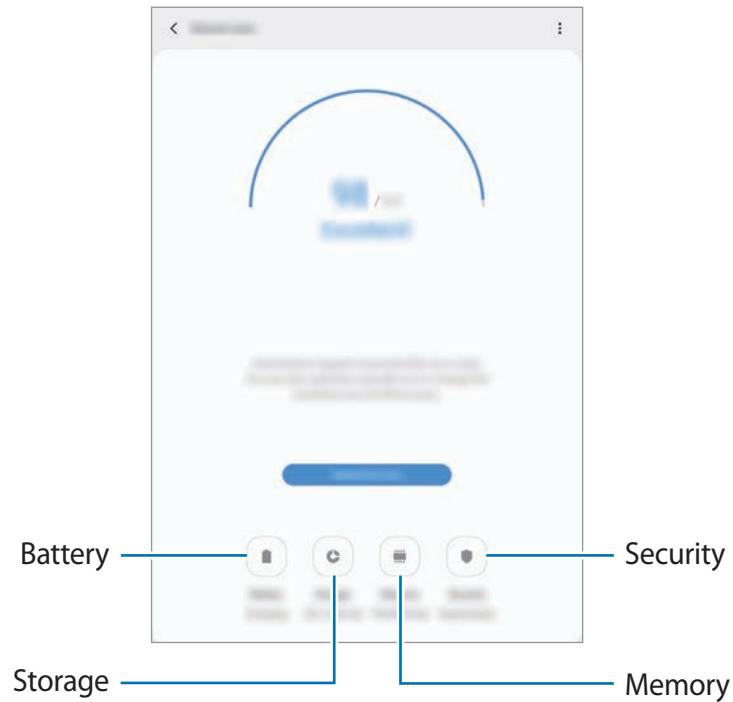

Using the quick optimisation feature

On the Settings screen, tap **Device care** → **Optimise now**.

The quick optimisation feature improves device performance through the following actions.

- Clearing some memory.
- Deleting unnecessary files and closing apps running in the background.
- Managing abnormal battery usage.
- Scanning for crashed apps and malware.

Battery

Check the remaining battery power and time to use the device. For devices with low battery levels, conserve battery power by activating power saving features.

On the Settings screen, tap **Device care** → **Battery**.



- The usage time left shows the time remaining before the battery power runs out. Usage time left may vary depending on your device settings and operating conditions.
- You may not receive notifications from some apps that use power saving mode.

Managing battery usage

Select a power mode that suits your device usage purposes.

Tap **Power mode** and select an option.

- **Optimised:** Optimised for a balance between the device's performance and battery usage.
- **Medium power saving:** Activate power saving mode to extend the battery's usage time.
- **Maximum power saving**
 - ▶ **SM-T395:** In maximum power saving mode, the device decreases battery consumption by activating night mode and limiting the apps and features available. Network connections, except for the mobile network, will be deactivated.
 - ▶ **SM-T390:** In maximum power saving mode, the device decreases battery consumption by activating night mode and limiting the apps and features available. Network connections will be deactivated.

Managing battery usage for each app

You can save battery power by preventing apps that are running in the background from using battery power when they are not being used. Select apps from the apps list and tap the **Put app to sleep** switch to activate the feature. Also, tap  → **Settings** and set up the options under **App power management**.

Storage

Check the status of the used and available memory.

On the Settings screen, tap **Device care** → **Storage**.



- The actual available capacity of the internal memory is less than the specified capacity because the operating system and default apps occupy part of the memory. The available capacity may change when you update the device.
- You can view the available capacity of the internal memory in the Specification section for your device on the Samsung website.

Managing the memory

To delete residual files, such as cache, tap **Clean now**. To delete files or uninstall apps that you do not use any more, select a category under **User data**. Then, tick items to select and tap **DELETE** or **UNINSTALL**.

Memory

On the Settings screen, tap **Device care** → **Memory**.

To speed up your device by stopping apps running in the background, tick apps from the apps list, and tap **Clean now**.

Security

Check the device's security status. This feature scans your device for malware.

On the Settings screen, tap **Device care** → **Security** → **Scan tablet**.

Apps

Manage the device's apps and change their settings. You can view the apps' usage information, change their notification or permission settings, or uninstall or disable unnecessary apps.

On the Settings screen, tap **Apps**.

General management

Customise your device's system settings or reset the device.

On the Settings screen, tap **General management**.

- **Language and input:** Select device languages and change settings, such as keyboards and voice input types. Some options may not be available depending on the selected language. Refer to [Adding device languages](#) for more information.
- **Date and time:** Access and alter the settings to control how the device displays the time and date.



If the battery remains fully discharged or removed from the device, the time and date is reset.

- **Contact us:** Ask questions or view frequently asked questions. Refer to [Samsung Members](#) for more information.
- **Reset:** Reset your device's settings or perform a factory data reset. You can reset all your settings, or only network settings, or accessibility settings. You can also set the device to restart at a preset time for device optimisation.

Adding device languages

You can add languages to use on your device.

- 1 On the Settings screen, tap **General management** → **Language and input** → **Language** → **Add language**.

To view all the languages that can be added, tap  → **All languages**.

- 2 Select a language to add.

- 3 To set the selected language as the default language, tap **Set as default**. To keep the current language setting, tap **Keep current**.

The selected language will be added to your languages list. If you changed the default language, the selected language will be added to the top of the list.

To change the default language from your languages list, drag  next to a language and move it to the top of the list. Then, tap **Apply**. If an app does not support the default language, the next supported language in the list will be used.

Accessibility

Configure various settings to improve accessibility to the device.

On the Settings screen, tap **Accessibility**.

- **Screen reader:** Activate Voice Assistant, which provides voice feedback. To view help information to learn how to use this feature, tap **Tutorial**.
- **Visibility enhancements:** Customise the settings to improve accessibility for visually impaired users.
- **Hearing enhancements:** Customise the settings to improve accessibility for users with hearing impairment.
- **Interaction and dexterity:** Customise the settings to improve accessibility for users who have reduced dexterity.
- **Advanced settings:** Configure settings for Direct access and notification features.
- **Installed services:** View accessibility services installed on the device.

Software update

Update your device's software via the firmware over-the-air (FOTA) service. You can also schedule software updates.

On the Settings screen, tap **Software update**.



If emergency software updates are released for your device's security and to block new types of security threats, they will be installed automatically without your agreement.

- **Download and install:** Check for and install updates manually.
- **Auto download over Wi-Fi:** Set the device to download updates automatically when connected to a Wi-Fi network.
- **Last update:** View information about the last software update.

Security updates information

Security updates are provided to strengthen the security of your device and protect your personal information. For security updates for your model, visit security.samsungmobile.com.



The website supports only some languages.

User manual

View help information to learn how to use the device and apps or configure important settings.

On the Settings screen, tap **User manual**.

About tablet

Access your device's information.

On the Settings screen, tap **About tablet**.

To change your device's name, tap **Edit**.

- **Status**

- ▶ **SM-T395:** View various device information, such as the SIM card status, Wi-Fi MAC address, and serial number.

- ▶ **SM-T390:** View various device information, such as the Wi-Fi MAC address and serial number.

- **Legal information:** View legal information related to the device, such as safety information and the open source licence.

- **Software information:** View the device's software information, such as its operating system version and firmware version.

- **Battery information:** View the device's battery status and information.

Appendix

Troubleshooting

Before contacting a Samsung Service Centre, please attempt the following solutions. Some situations may not apply to your device.

When you turn on your device or while you are using the device, it prompts you to enter one of the following codes:

- **Password:** When the device lock feature is enabled, you must enter the password you set for the device.
- **PIN:** When using the device for the first time or when the PIN requirement is enabled, you must enter the PIN supplied with the SIM or USIM card. You can disable this feature by using the Lock SIM card menu.
- **PUK:** Your SIM or USIM card is blocked, usually as a result of entering your PIN incorrectly several times. You must enter the PUK supplied by your service provider.
- **PIN2:** When you access a menu requiring the PIN2, you must enter the PIN2 supplied with the SIM or USIM card. For more information, contact your service provider.

Your device displays network or service error messages

- When you are in areas with weak signals or poor reception, you may lose reception. Move to another area and try again. While moving, error messages may appear repeatedly.
- You cannot access some options without a subscription. For more information, contact your service provider.

Your device does not turn on

When the battery is completely discharged, your device will not turn on. Fully charge the battery before turning on the device.

- The battery may not be inserted properly. Insert the battery again.
- Wipe both gold-coloured contacts and insert the battery again.

The touchscreen responds slowly or improperly

- If you attach a screen protector or optional accessories to the touchscreen, the touchscreen may not function properly.
- If you are wearing gloves, if your hands are not clean while touching the touchscreen, or if you tap the screen with sharp objects or your fingertips, the touchscreen may malfunction.
- The touchscreen may malfunction in humid conditions or when exposed to water.
- Restart your device to clear any temporary software bugs.
- Ensure that your device software is updated to the latest version.
- If the touchscreen is scratched or damaged, visit a Samsung Service Centre.

Your device freezes or encounters a fatal error

Try the following solutions. If the problem is still not resolved, contact a Samsung Service Centre.

Restarting the device

If your device freezes or hangs, you may need to close apps or turn off the device and turn it on again.

Forcing restart

If your device is frozen and unresponsive, press and hold the Power key and the Volume Down key simultaneously for more than 7 seconds to restart it.

Resetting the device

If the methods above do not solve your problem, perform a factory data reset.

Launch the **Settings** app and tap **General management** → **Reset** → **Factory data reset** → **Reset** → **Delete all**. Before performing the factory data reset, remember to make backup copies of all important data stored in the device.

Calls are not connected

- Ensure that you have accessed the right cellular network.
- Ensure that you have not set call barring for the phone number you are dialling.
- Ensure that you have not set call barring for the incoming phone number.

Others cannot hear you speaking on a call

- Ensure that you are not covering the built-in microphone.
- Ensure that the microphone is close to your mouth.
- If using an earphone, ensure that it is properly connected.

Sound echoes during a call

Adjust the volume by pressing the Volume key or move to another area.

A cellular network or the Internet is often disconnected or audio quality is poor

- Ensure that you are not blocking the device's internal antenna.
- When you are in areas with weak signals or poor reception, you may lose reception. You may have connectivity problems due to issues with the service provider's base station. Move to another area and try again.
- When using the device while moving, wireless network services may be disabled due to issues with the service provider's network.

The battery icon is empty

Your battery is low. Charge the battery.

The battery does not charge properly (For Samsung-approved chargers)

- Ensure that the charger is connected properly.
- If the battery terminals are dirty, the battery may not charge properly or the device may turn off. Wipe both gold-coloured contacts and try charging the battery again.

The battery depletes faster than when first purchased

- When you expose the device or the battery to very cold or very hot temperatures, the useful charge may be reduced.
- Battery consumption will increase when you use certain features or apps, such as GPS, games, or the Internet.
- The battery is consumable and the useful charge will get shorter over time.

Error messages appear when launching the camera

Your device must have sufficient available memory and battery power to operate the camera app. If you receive error messages when launching the camera, try the following:

- Charge the battery.
- Free some memory by transferring files to a computer or deleting files from your device.
- Restart the device. If you are still having trouble with the camera app after trying these tips, contact a Samsung Service Centre.

Photo quality is poorer than the preview

- The quality of your photos may vary, depending on the surroundings and the photography techniques you use.
- If you take photos in dark areas, at night, or indoors, image noise may occur or images may be out of focus.

Error messages appear when opening multimedia files

If you receive error messages or multimedia files do not play when you open them on your device, try the following:

- Free some memory by transferring files to a computer or deleting files from your device.
- Ensure that the music file is not Digital Rights Management (DRM)-protected. If the file is DRM-protected, ensure that you have the appropriate licence or key to play the file.
- Ensure that the file formats are supported by the device. If a file format is not supported, such as DivX or AC3, install an app that supports it. To confirm the file formats that your device supports, visit www.samsung.com.
- Your device supports photos and videos captured with the device. Photos and videos captured by other devices may not work properly.
- Your device supports multimedia files that are authorised by your network service provider or providers of additional services. Some content circulated on the Internet, such as ringtones, videos, or wallpapers, may not work properly.

Bluetooth is not working well

If another Bluetooth device is not located or there are connection problems or performance malfunctions, try the following:

- Ensure that the device you wish to connect with is ready to be scanned or connected to.
- Ensure that your device and the other Bluetooth device are within the maximum Bluetooth range (10 m).
- On your device, launch the **Settings** app, tap **Connections**, and then tap the **Bluetooth** switch to re-activate it.
- On your device, launch the **Settings** app, tap **General management** → **Reset** → **Reset network settings** → **Reset settings** to reset network settings. You may lose registered information when performing the reset.

If the tips above do not solve the problem, contact a Samsung Service Centre.

A connection is not established when you connect the device to a computer

- Ensure that the USB cable you are using is compatible with your device.
- Ensure that you have the proper driver installed and updated on your computer.
- If you are a Windows XP user, ensure that you have Windows XP Service Pack 3 or higher installed on your computer.

Your device cannot find your current location

GPS signals may be obstructed in some locations, such as indoors. Set the device to use Wi-Fi or a mobile network to find your current location in these situations.

Data stored in the device has been lost

Always make backup copies of all important data stored in the device. Otherwise, you cannot restore data if it is corrupted or lost. Samsung is not responsible for the loss of data stored in the device.

A small gap appears around the outside of the device case

- This gap is a necessary manufacturing feature and some minor rocking or vibration of parts may occur.
- Over time, friction between parts may cause this gap to expand slightly.

There is not enough space in the device's storage

Delete unnecessary data, such as cache, using the device care feature or manually delete unused apps or files to free up storage space.

The Apps button does not appear on the Home screen

Without using the Apps button, you can open the Apps screen by swiping upwards or downwards on the Home screen. To display the Apps button at the bottom of the Home screen, launch the **Settings** app, tap **Display** → **Home screen**, and then tap the **Apps button** switch to activate it.

The screen brightness adjustment bar does not appear on the notification panel

Open the notification panel by dragging the status bar downwards, and then drag the notification panel downwards. Tap  next to the brightness adjustment bar and tap the **Show control on top** switch to activate it.

Samsung Cloud does not work

- Ensure that you are connected to a network properly.
- During a Samsung Cloud's service check, you cannot use Samsung Cloud. Try again later.

Copyright

Copyright © 2019 Samsung Electronics

This manual is protected under international copyright laws.

No part of this manual may be reproduced, distributed, translated, or transmitted in any form or by any means, electronic or mechanical, including photocopying, recording, or storing in any information storage and retrieval system, without the prior written permission of Samsung Electronics.

Trademarks

- SAMSUNG and the SAMSUNG logo are registered trademarks of Samsung Electronics.
- Bluetooth® is a registered trademark of Bluetooth SIG, Inc. worldwide.
- Wi-Fi®, Wi-Fi Protected Setup™, Wi-Fi Direct™, Wi-Fi CERTIFIED™, and the Wi-Fi logo are registered trademarks of the Wi-Fi Alliance.
- Manufactured under license from Dolby Laboratories. Dolby, Dolby Atmos, and the double-D symbol are trademarks of Dolby Laboratories.
- All other trademarks and copyrights are the property of their respective owners.